

# Service Manual THE FISHER®

## Consoles

*Imbasock*

*230  
410  
460  
480*

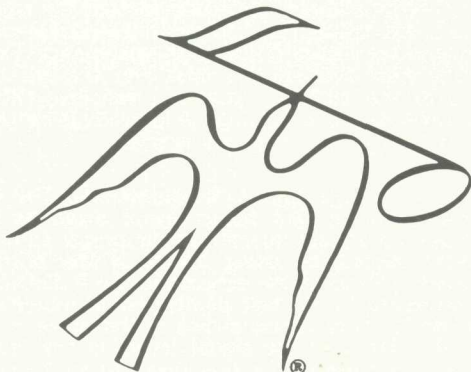
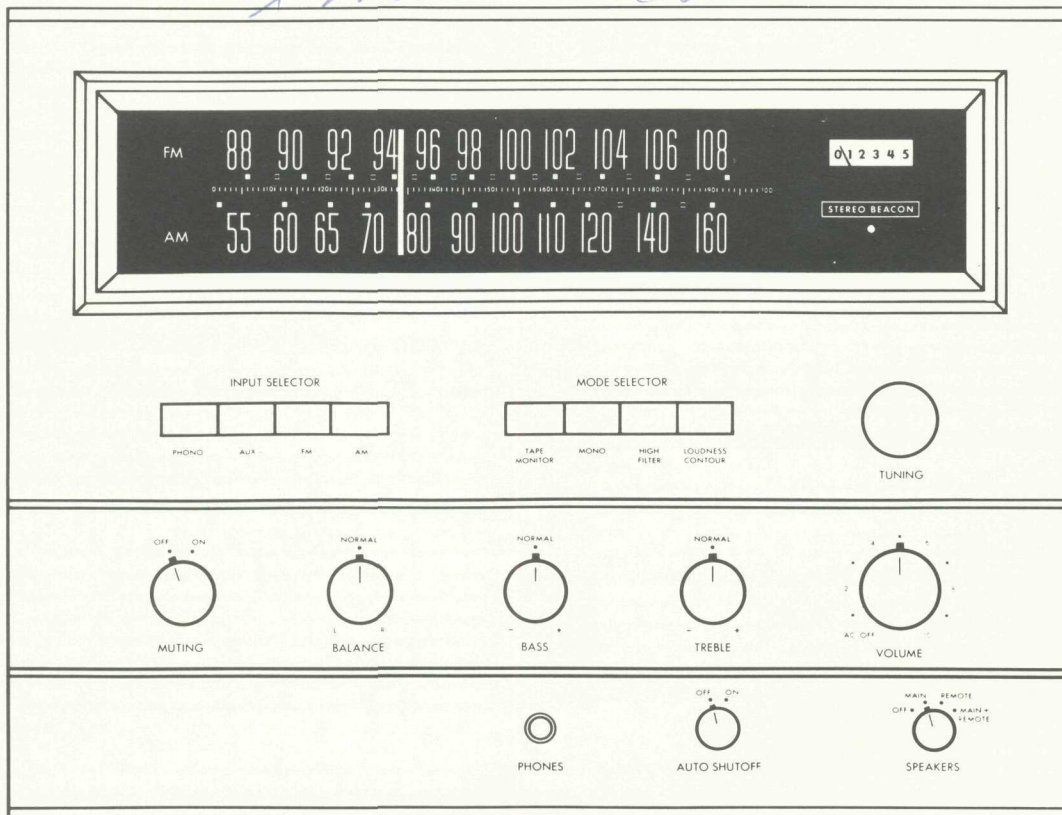

# 69T

RECEIVER

**CAUTION:** This is a FISHER precision high-fidelity instrument. It should be serviced only by qualified personnel — trained in the repair of transistor equipment and printed circuitry.

### EQUIPMENT AND TOOLS NEEDED

The following are needed to completely test and align modern high-fidelity instruments such as amplifiers, tuners and receivers.

#### Test Instruments

Vacuum-Tube Volt-ohmmeter DC VTVM  
Audio (AC) Vacuum-Tube Voltmeter (AC VTVM)  
Oscilloscope (Flat to 100 kc minimum)  
Audio (Sine-wave) Generator  
Intermodulation Analyzer  
Sweep (FM) Generator (88 to 108 mc)  
Marker Generator  
Multiplex Generator (preferably with RF output — FISHER Model 300 or equal).

#### Miscellaneous

Adjustable-Line-Voltage Transformer or line-voltage regulator  
Load Resistors (2) — 8-ohm, 50-watt (or higher)  
Stereo source (Turntable with stereo cartridge or Tape Deck)  
Speakers (2) Full-range, for listening tests  
Soldering iron (with small-diameter tip). Fully insulated from power line.

### PRECAUTIONS

Many of the items below are included just as a reminder — they are normal procedures for experienced technicians. Shortcuts can be taken but often they cause additional damage — to transistors, circuit components or the printed-circuit board.

**Soldering**—A well-tinned, hot, clean soldering iron tip will make it easier to solder without damage to the printed-circuit board or the many many circuit components mounted on it. It is not the wattage of the iron that counts — it is the heat available at the tip. Low-wattage soldering irons will often take too long to heat a connection — pigtail leads will get too hot and damage the part. Too much heat, applied too long, will damage the printed-circuit board. Some 50-watt irons reach temperatures of 1,000° F — others will hardly melt solder. Small-diameter tips should be used for single solder connections — larger pyramid and chisel tips are needed for larger areas.

- When removing defective resistors, capacitors, etc., the leads should be cut as close to the body of the circuit component as possible. (If the part is not being returned for in-warranty factory replacement it may be cut in half — with diagonal-cutting pliers — to make removal easier.)
- Special de-soldering tipleths are made for unsoldering multiple-terminal units like IF transformers and electrolytic capacitors. By unsoldering all terminals at the same time the part can be removed with little chance of breaking the printed-circuit board.
- Always disconnect the chassis from the power line when soldering. Turning the power switch OFF is not enough. Power-line leakage paths, through the heating element, can destroy transistors.

**Transistors**—Never attempt to do any work on the transistor amplifiers without first disconnecting the AC-power linecord — wait until the power supply filter-capacitors have discharged.

- Guard against shorts — it takes only an instant for a base-to-collector short to destroy that transistor and possibly others direct-coupled to it. [In the time it takes for a dropped machine screw, washer or even the screwdriver, to glance off a pair of socket terminals (or between a terminal and the chassis) a transistor can be ruined.]
- DO NOT bias the base of any transistor to, or near, the same voltage applied to its collector.
- DO NOT use an ohmmeter for testing transistors. The voltage applied through the test probes may be higher than the base-emitter breakdown voltage of the transistor.

**Output Stage and Driver**—Replacements for output and driver transistors, if necessary, must be made from the same beta group as the original type. The beta group is indicated by a colored dot on the mounting flange of the transistor. Be sure to include this information, when ordering replacement transistors.

- If one output transistor burns out (open or shorts), always remove all output transistors in that channel and check the bias adjustment, the control and other parts in the network with an ohmmeter before inserting a new transistor. All output transistors in one channel will be destroyed if the base-biasing circuit is open on the emitter end.

- When mounting a replacement power transistor be sure the bottom of the flange, the mica insulator and the surface of the heat sink are free of foreign matter. Dust and grit can prevent perfect contact. This reduces heat transfer to the heat sink. Metallic particles can puncture the insulator and cause shorts — ruining the transistor.

- Silicone grease must be used between the transistor and the mica insulator and between the mica and the heat sink for best heat conduction. Heat is the greatest enemy of electronic equipment. It can shorten the life of transistors, capacitors and resistors. (Use Dow-Corning DC-3 or C20194 or equivalent compounds made for power transistor heat conduction.)

- Use care when making connections to speakers and output terminals. Any frayed wire ends can cause shorts that may burn out the output transistors — they are direct-coupled to the speakers. There is no output transformer — nothing to limit current through the transistors except the fuses. To reduce the possibility of shorts at the speakers, lugs should be used on the exposed ends — at least the ends of the stranded wires should be tinned to prevent frayed wire ends. The current in the speakers and output circuitry is quite high. Any poor contact or small-size wire, can cause power losses in the speaker system. Use 14 or 16 AWG for long runs of speaker-connecting wiring.

**DC-Voltage Measurements**—These basic tests of the transistor circuitry are made without the signal generator. Without any signal input measure the circuit voltages — as indicated on the schematic. The voltage difference between the base and the emitter should be in the millivolt range — a sensitive DC meter is needed for these readings. A low-voltage range of 1 volt, full scale — or lower — is needed.

**Audio-Voltage (gain) Measurements**—The schematic and printed-circuit board layout diagrams are used. Input signals are injected at the proper points — found most quickly by using layout of the printed-circuit board instead of the schematic. An AUDIO (AC) VTVM connected to the test points should indicate voltages close to those values shown in the boxes on the schematic. Many of the signal levels in the input stages are only a few millivolts — they can not be read on the AC ranges supplied on most Vacuum-Tube AC/DC Volt-ohmmeters (VTVMs). Even with a 1-volt range a signal level of 100 millivolts (.1 volt) will be the first 1/10 of the meter scale. A reading of 1 millivolt (.001 volt) will hardly even move the meter needle.

## DIAL STRINGING PROCEDURE

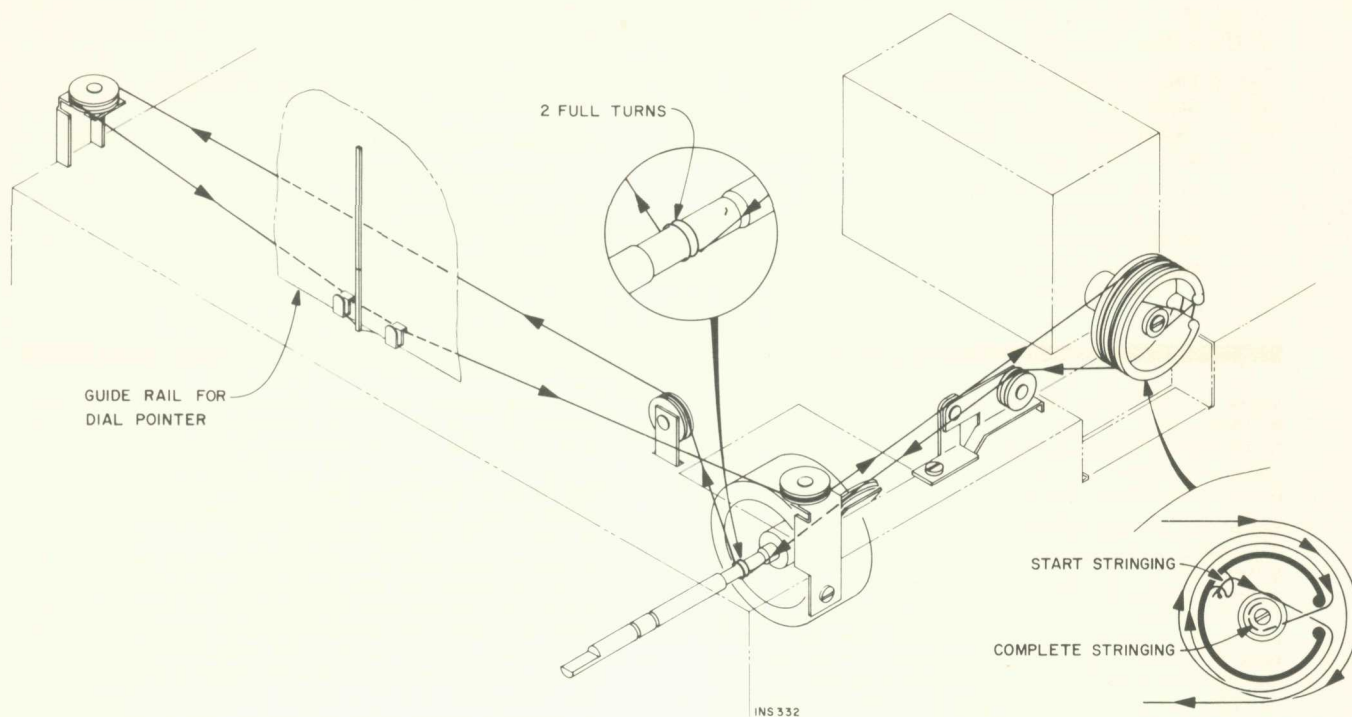

1 - Rotate variable-capacitor drive-drum to its maximum clockwise position.

2 - Fasten dial cord to drum. Wind dial cord clockwise around drum as shown in detail drawing. Keep dial cord taut while stringing to pre-

vent slippage when stringing is completed.

3 - After stringing is completed rotate tuning drive to extreme counterclockwise position and set dial pointer to zero on the logging scale. Then cement pointer to dial cord.

If replacement parts are out of stock, locally, they may be obtained directly from the Parts Department of FISHER Radio Corporation. They will be shipped "best way", either prepaid or C.O.D. unless otherwise specified.

For instrument-operation information and technical assistance write Richard Hamilton, Customer Relations Department, FISHER Radio Corporation, Long Island City, New York 11101.

# AM-FM FRONT-END

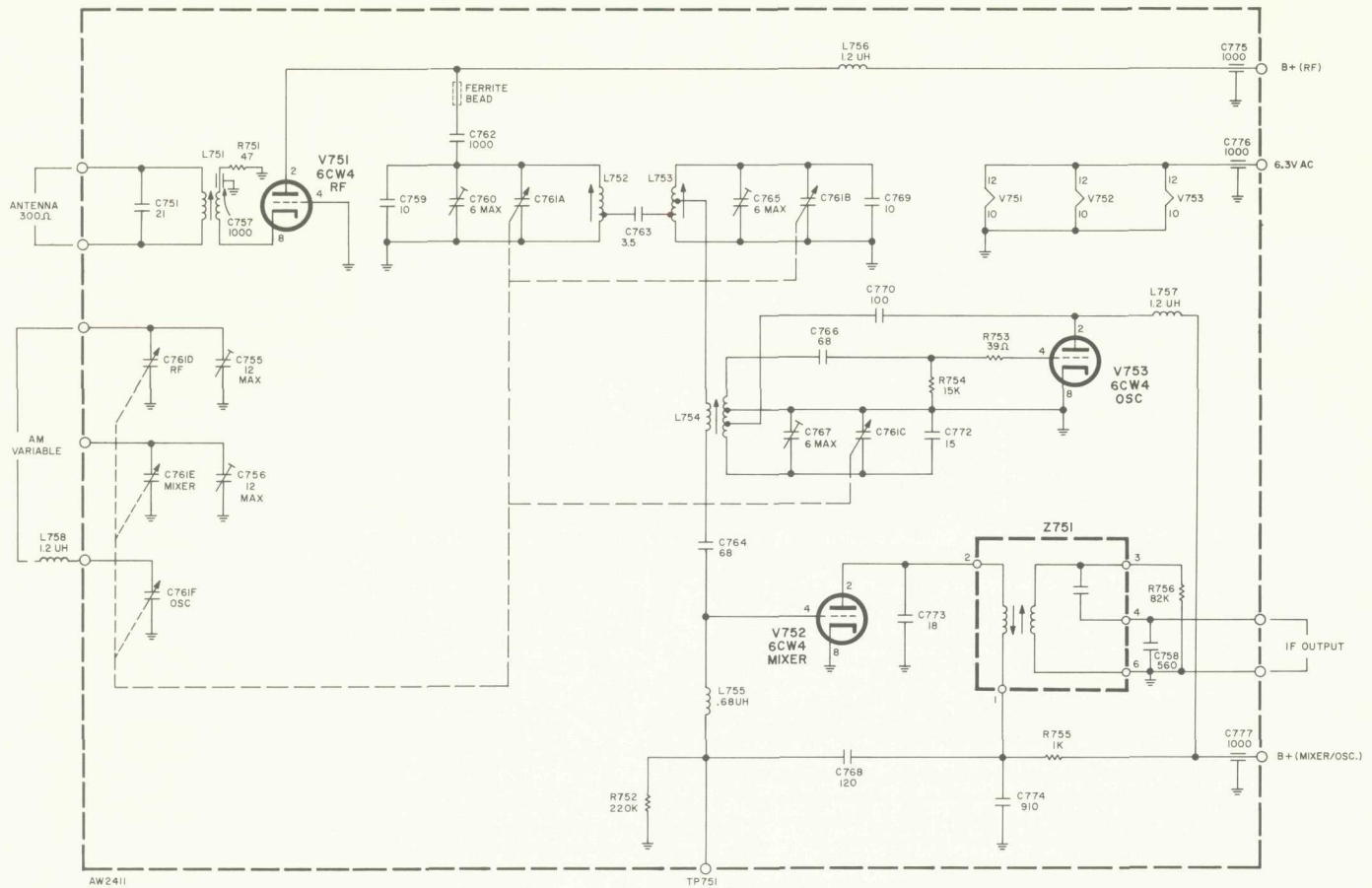

## CAPACITORS

10% Tolerance for all fixed capacitors, unless otherwise noted or marked GMV (guaranteed minimum value). All capacitors not marked uF are pF (uuF).

Symbol	Description	Part No.
C751	Ceramic, 21, 5%, N750, 1000V	C50070-32
C752, 3, 4	-Deleted-	-
C755, 756	* Trimmer, Ceramic, 12pF	C50B792-1
C757	* Ceramic, Feedthru, 1000	C592-187
C758	Polystyrene, 560, 5%, 33V	C50B636-10
C759	* Ceramic, 10, 5%, NPO, 1000V	C50070-39
C760	* Trimmer, Ceramic, 6pF	C50B792-2
C761A-F	* Variable, AM-FM Tuning	C1279C109
C762	Ceramic, 1000, 1000	C50072-3
C763	* Ceramic, 3.5, ±.25pF, NPO, 1000V	C50070-46
C764	Ceramic, 68, 5%, N750, 1000V	C50070-35
C765	* Trimmer, Ceramic, 6pF	C50B792-2
C766	Ceramic, 68pF, 5% N750, 1000V	C50070-35
C767	Trimmer, Ceramic, 6pF	C50B792-2
C768	Mica, 120, 5%, 300V	C50332-11
C769	* Ceramic, 10, 5%, NPO, 1000V	C50070-39
C770	* Ceramic, 100, N1500, 1000V	C50070-6
C771	-Deleted-	-
C772	* Ceramic, 15, 5%, NPO, 500V	CC20CG150J5
C773	* Ceramic, 18, 5%, NPO, 1000V	C50070-49
C774	Mica, 910, 5%, 500V	C50332-12
C775, 776, 777	* Feedthru, Ceramic, 1000	C592-187

## RESISTORS

Symbol	Description	Part No.
R751	Dep. Carbon, 47, 5%, 1/8W	R12DC470J
R752	Dep. Carbon, 220K, 5%, 1/8W	R12DC224J
R753	* Dep. Carbon, 39, 5%, 1/8W	R12DC390J
R754	* Dep. Carbon, 15K, 5%, 1/8W	R12DC153J
R755	Dep. Carbon, 1K, 5%, 1/8W	R12DC102J
R756	Dep. Carbon 82K, 5%, 1/8W	R12DC823J

## MISCELLANEOUS

Symbol	Description	Part No.
L751	* Coil, FM Antenna	L818-113
L752	* Coil, FM RF	L1368A112
L753	* Coil, FM Mixer	L1368A113
L754	* Coil, FM Oscillator	AS1368B114
L755	* Coil, .68 Microhenry	L50066-1
L756, 757	* Coil, 1.2 Microhenry	L50066-3
L758, 757,	Coil, 1.2, Microhenry	L50066-3
Z751	Transformer, FM IF	ZZ50C210-88

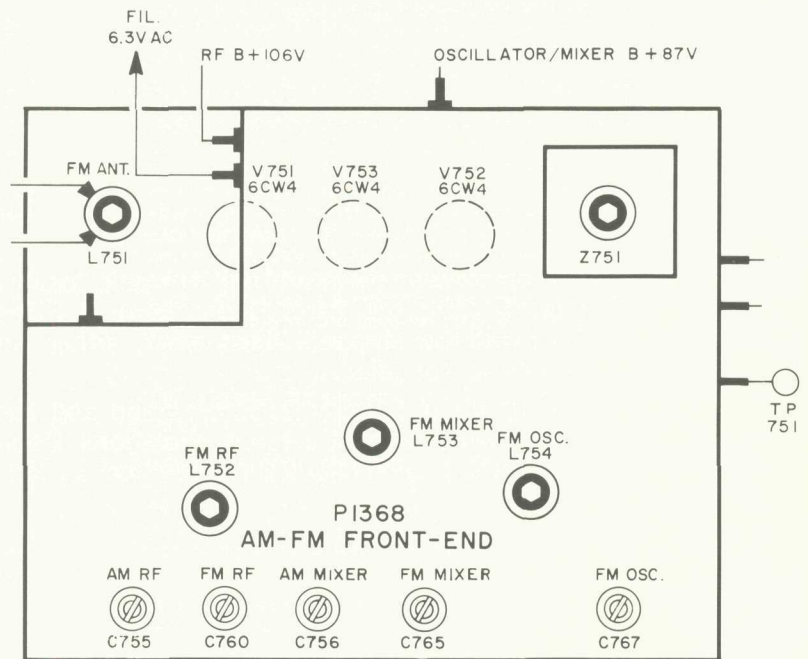

NOTE: Except for sections of C761 all AM Front-end components are listed in MAIN CHASSIS Parts Description.

\* Should any defect occur that cannot be remedied by replacing nuvistors (tubes) or normal realignment procedures the unit *may* be returned to the manufacturer for repair. Replacing the electronic components indicated (\*) in the parts description list is not recommended.

(L-2) 753 (1368-A) IF

## AM IF ALIGNMENT

- Connect 455 kHz (KC) sweep generator output lead to the collector of Q15 (pin 1 of Z3). Set modulation for approximately  $\pm 30$  kHz sweep. Keep generator output as low as possible during alignment procedure.
- Connect scope to TP2 and short C761D (AM RF-amplifier tuning section) rotor-to-stator. A short between the AM antenna terminal and ground is not sufficient to prevent pickup on the AM ferrite-loop antenna.
- Adjust L3 and the bottom core of Z3 for maximum gain and a symmetrical IF amplifier response curve.
- Connect 455 kHz sweep generator output lead to TP1. Do not change settings, made above, except to reduce RF output to keep it as low as possible.
- With scope still connected to TP2 and the AM RF amplifier tuning section shorted, adjust Z3 top and Z2 top and bottom for maximum gain and a symmetrical IF amplifier response curve.
- Disconnect scope from TP2 and remove short from rotor-to-stator.

## AM FRONT-END ALIGNMENT

- Set dial pointer to zero (0) calibration mark on logging scale. If dial pointer does not coincide with the 0 at the extreme end of the knob rotation reposition the pointer assembly on the dial cord and cement pointer in place to prevent slippage.
- Set AM TUNING dial pointer to 60 and set RF generator to 600 kHz or 0.600 MHz (MC). DO NOT USE MODULATION (AM or FM) and keep RF output as low as possible during alignment procedure.
- Adjust AM OSCILLATOR coil (L2) core for maximum indication on the front-panel tuning meter.
- Set AM TUNING dial pointer to 140 and set RF generator to 1.4 MHz DO NOT USE MODULATION (AM or FM) and keep RF output as low as possible.
- Adjust OSCILLATOR trimmer capacitor (C13) for maximum indication on the front-panel tuning meter.
- Connect RF generator to AM ANTENNA terminals.
- Set AM TUNING dial pointer to 60 and set RF generator to 600 kHz. (DO NOT USE MODULATION (AM or FM) and keep RF output as low as possible.)
- Adjust AM MIXER coil (Z1) core and AM LOOP ANTENNA (L1) for maximum indication on the front-panel tuning meter.
- Set AM TUNING dial pointer to 140 and set RF generator to 1.4 MHz. (DO NOT USE MODULATION (AM or FM) and keep RF output as low as possible.)
- Adjust trimmer capacitors for AM MIXER (C756) and AM RF (C755) sections for maximum indication on the front-panel tuning meter.
- Repeat OSCILLATOR, RF and MIXER alignment procedure several times until accurate calibration and maximum gain are obtained.

## FM FRONT-END ALIGNMENT

- Set TUNING dial pointer to zero (0) calibration mark on logging scale. If dial pointer does not coincide with the 0 at the extreme end of the knob rotation reposition the pointer assembly on the dial cord and cement the pointer in place to prevent slippage.
- Connect DC VTVM to TP301 on the IF board.
- Connect RF generator (with two 120-ohm composition resistors in series with the leads) to the LOCAL antenna terminals.
- Set RF generator frequency and FM TUNING dial pointer to 90 MHz (MC). DO NOT USE MODULATION (AM or FM) and keep RF output as low as possible during alignment procedure.
- Adjust FM OSCILLATOR coil (L754) core first—then adjust the FM MIXER coil (L753) and FM RF coil (L752) cores for maximum DC VTVM reading.
- Set RF generator frequency and FM TUNING dial pointer to 106 MHz.
- Adjust FM OSCILLATOR trimmer (C767) first—then adjust FM MIXER (C765) and FM RF (C755) trimmers for maximum DC VTVM reading.
- Repeat OSCILLATOR, MIXER and RF alignment procedure several times until accurate calibration and maximum gain are obtained. Keep the output of the generator as low as possible during all adjustments.

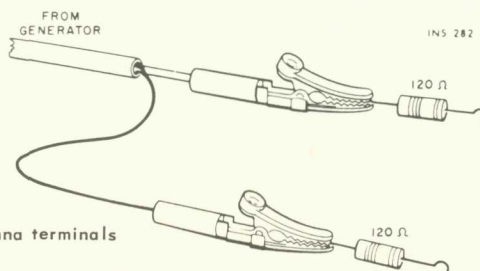

Generator connections to antenna terminals

## OUTPUT-STAGE INTERMODULATION TEST

- Connect an 8-ohm, 50-watt resistor across the LEFT SPKRS terminals.
- In parallel to the load resistor connect the input leads of an IM (Inter-Modulation) distortion analyzer.
- Connect the IM-analyzer generator output to the left MON IN jack.
- Apply AC power and rotate VOLUME control to its maximum clockwise position—full volume.
- Increase signal input (from IM-analyzer generator) for 20-watts output (12.5 VAC across 8-ohm load resistor). AFTER ONE FULL MINUTE OF WARM-UP TIME PROCEED TO NEXT STEP. (The warm-up time is very important (to get proper adjustment) — the characteristics of the transistors change slightly as their internal temperature rises. Once they are warm the tests and adjustments should be completed without delay — before they can cool off.

- Reduce IM-analyzer generator output for 5 watts output from the amplifier (5.16 VAC across 8-ohm load resistor).
- Check LEFT channel for less than (0.6%) IM distortion across the 8-ohm load resistance.
- Increase IM-analyzer generator output for 35 watts (16 VAC across 8-ohm load) and read less than 1% IM distortion.
- Repeat all the steps above for the RIGHT channel.

NOTE—If any of the above instructions differ from those in the IM analyzer instruction manual it is best to follow those in the IM manual. If a load resistor of 50-watts rating is built into the IM analyzer, a separate load resistor is not required for the channel under test—one should be wired across the other channel as a precaution. For best results the IM-analyzer range switch should be set to a range that gives a reading in the center to full-scale portion of the meter scale to get the greatest accuracy.

## POWER OUTPUT MEASUREMENT

The power-output stage of this unit is designed to deliver its full-rated power with program material (voice or music) into 4-to-16-ohm loads for indefinite periods.

When a constant audio tone is used as a signal to measure the *continuous RMS power output* certain precautions must be taken.

- Measure the power output of one channel at a time.
- Limit the measurement period to 10 minutes (with a load resistance between 4 and 16 ohms).

Should it ever be necessary to measure the power output of *both channels simultaneously*, use a load of 4 or 8 ohms (per channel), limit measurement to a period *not longer than 1 minute* for a 4-ohm load or to *5 minutes* for an 8-ohm load.

## POWER TRANSISTOR TEST

If a power-transistor tester is not available the circuit in Figure 1 can be used to determine the DC beta of the transistors. This is not a complete test of the transistor.

**OPERATION:** Connect the transistor to the test circuit. Adjust R2 for a 0.5-ampere reading on M2 in the collector circuit. The DC beta is then calculated

$$\text{by: DC beta} = \frac{\text{reading of M2}}{\text{reading of M1}}$$

The DC beta should be between 50 and 250.

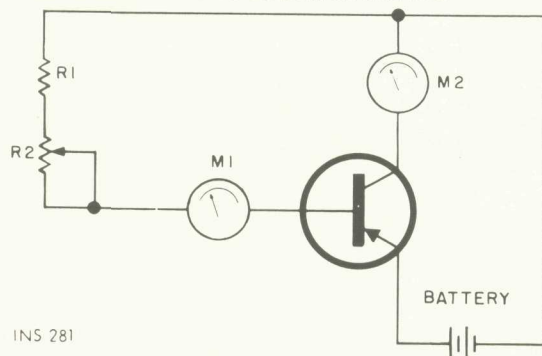

INS 281

Voltage tests can be made with safety — without ruining transistors — by substituting resistors for the emitter-collector circuit of the power transistors.

Parts list for test circuit.

R1	100 ohms, ½W
R2	1.5K, ½W
M1	0-10mA milliammeter
M2	0-1A ammeter
Battery	1.5-3V at 1 ampere

**Output Stage and Driver—**Replacements for output and driver transistors, if necessary, must be made from the same beta group as the original type. The beta group is indicated by a colored dot on the mounting flange of the transistor. Be sure to include this information, when ordering replacement transistors.

# 1285 PREAMPLIFIER

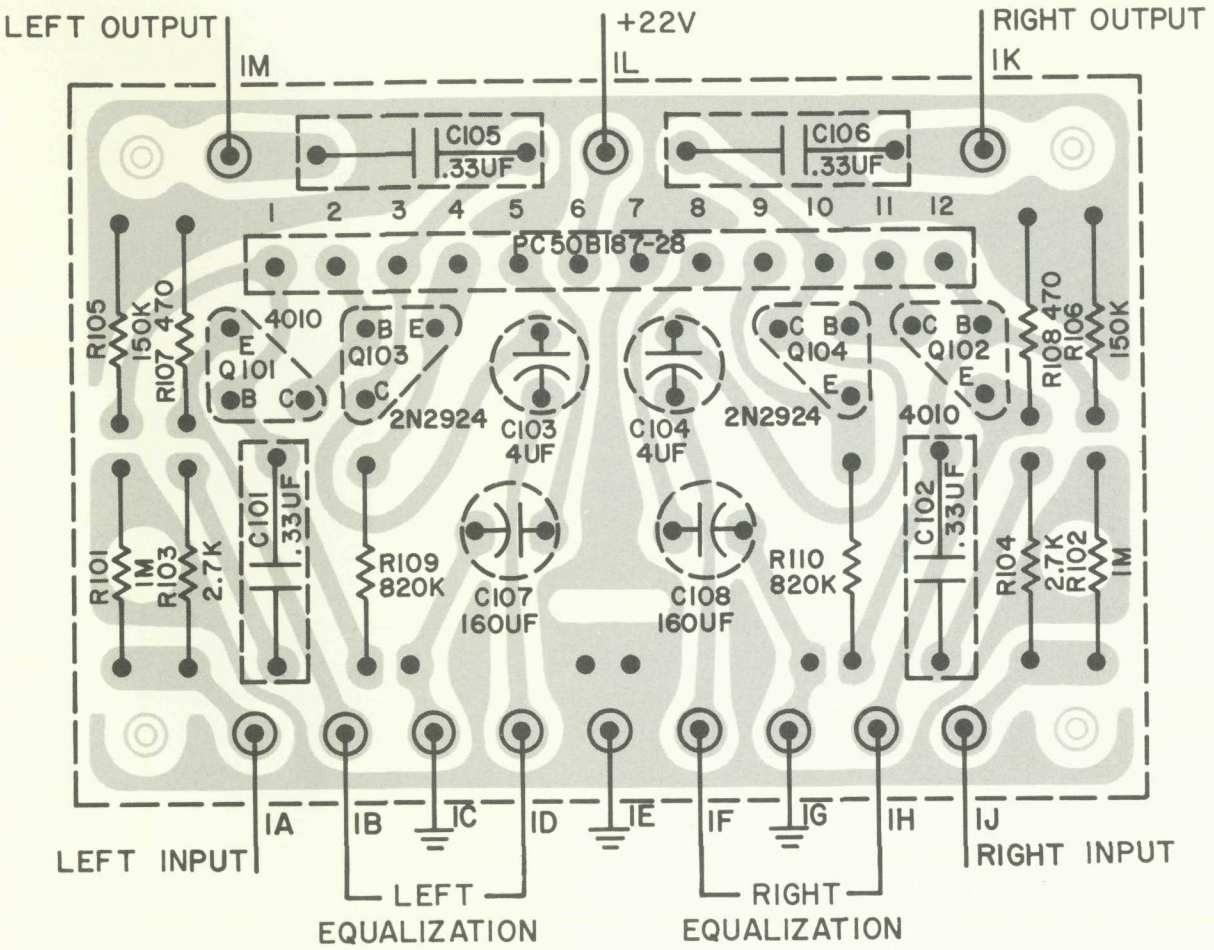
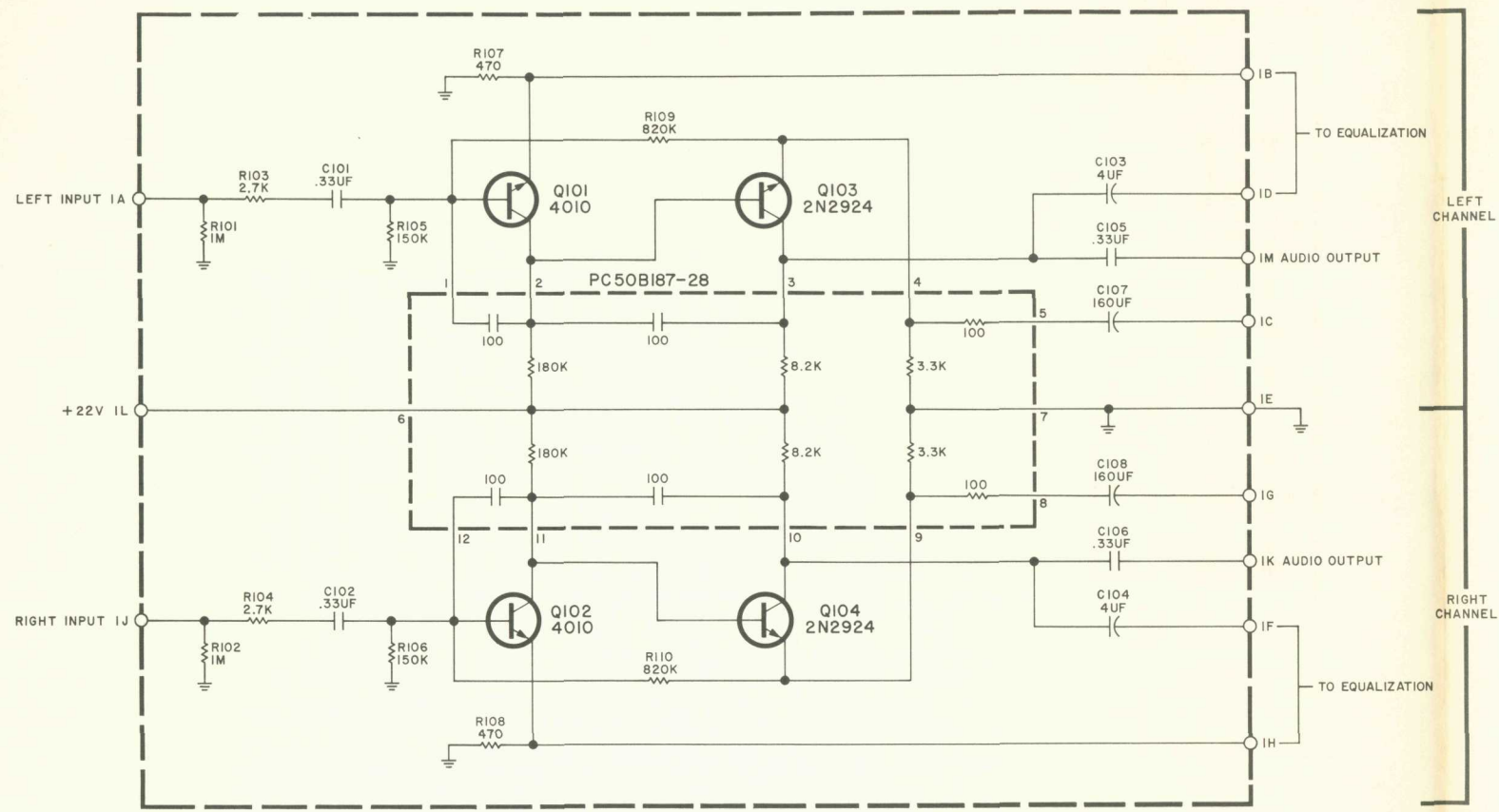

## PARTS DESCRIPTION LIST

CAPACITORS		
Symbol	Description	Part No.
C101, 102	Mylar, .33uF, 10%, 250V	C50B638-10
C103, 104	Electrolytic, 4uF, 35V	C50B637-1
C105, 106	Mylar, .33uF, 10%, 250V	C50B638-10
C107, 108	Electrolytic, 160uF, 6V	C50B637-3

RESISTORS		
Symbol	Description	Part No.
R101, 102	Dep. Carbon, 1M	R12DC105J

MISCELLANEOUS		
Symbol	Description	Part No.
-	Printed Circuit Board	P1285
-	Printed Circuit	PC50B187-28
-	Socket, Transistor	X50B779-2
Q101, 102	Transistor, SE4010	TR4010-2
Q103, 104	Transistor, 2N2924	TR2924-18

  

R103, 104	Composition, 2.7K, 10%, 1/2W	RC20BF272K
R105, 106	Dep. Carbon, 150K	R12DC154J
R107, 108	Dep. Carbon, 470	R12DC471J
R109, 110	Dep. Carbon, 820K	R12DC824J

## OUTPUT-STAGE INTERMODULATION TEST

- Connect an 8-ohm, 50-watt resistor across the LEFT SPKRS terminals.
  - In parallel to the load resistor connect the input leads of an IM (Inter-Modulation) distortion analyzer.
  - Connect the IM-analyzer generator output to the left MON IN jack.
  - Apply AC power and rotate VOLUME control to its maximum clockwise position—full volume.
  - Increase signal input (from IM-analyzer generator) for 20-watts output (12.5 VAC across 8-ohm load resistor). AFTER ONE FULL MINUTE OF WARM-UP TIME PROCEED TO NEXT STEP. (The warm-up time is very important (to get proper adjustment) — the characteristics of the transistors change slightly as their internal temperature rises. Once they are warm the tests and adjustments should be completed without delay — before they can cool off.
  - Reduce IM-analyzer generator output for 5 watts output from the amplifier (5.16 VAC across 8-ohm load resistor).
  - Adjust LEFT channel BIAS ADJUST control for minimum IM distortion (less than 0.8%) across the 8-ohm load resistor.
  - Increase IM-analyzer generator output for 35 watts—about 16 VAC across the 8-ohm load resistor. REPEAT all the steps above for RIGHT channel BIAS ADJUST.
- NOTE—If any of the above instructions differ from those in the IM analyzer instruction manual it is best to follow those in the IM manual. If a load resistor of 50-watts rating is built into the IM analyzer, a separate load resistor is not required for the channel under test—one should be wired across the other channel as a precaution. For best results the IM-analyzer range switch should be set to a range that gives a reading in the center to full-scale portion of the meter scale to get the greatest accuracy.

# 1381 IF AMPLIFIER

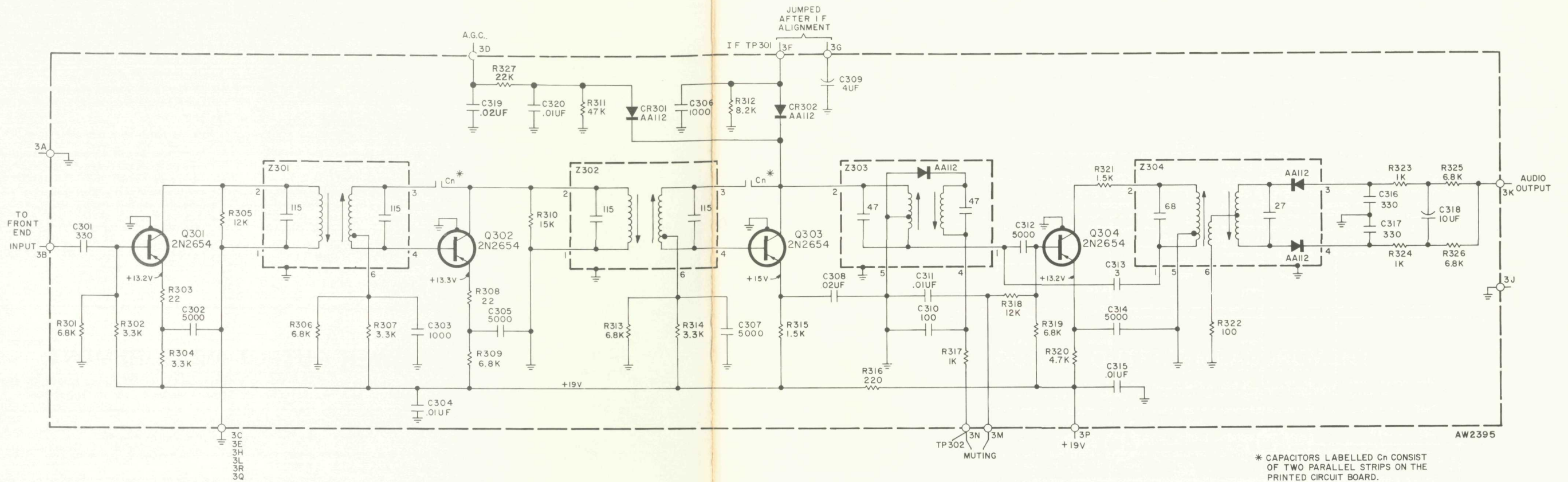

\* CAPACITORS LABELLED Cn CONSIST OF TWO PARALLEL STRIPS ON THE PRINTED CIRCUIT BOARD.

## PARTS DESCRIPTION LIST

### CAPACITORS

Symbol	Description	Part No.	Symbol	Description	Part No.	Symbol	Description	Part No.
C301	Ceramic, 330pF, 10%, 1000V	C50B569-1	R306	6.8K	R12DC682J	C311	Ceramic, .01uF, +80-20%, 500V	C50B570-1
C302	Ceramic, 5000pF, 20%, 500V	C50B567-2	R307	3.3K	R12DC332J	C312	Ceramic, 5000pF, 20%, 500V	C50B567-2
C303	Ceramic, 1000pF, 10%, 1000V	C50B569-3	R308	22	R12DC220J	C313	Ceramic, 3pF, 10%, NPO, 1000V	C50070-28
C304	Ceramic, .01uF, +80-20%, 500V	C50B570-1	R309	6.8K	R12DC682J	C314	Ceramic, 5000pF, 20%, 500V	C50B567-2
C305	Ceramic, 5000pF, 20%, 500V	C50B567-2	R310	15K	R12DC153J	C315	Ceramic, .01uF +80-20%, 500V	C50B570-1
C306	Ceramic, 1000pF, 20%, 1000V	C50B569-4	R311	47K	R12DC473J	C316, 317	Ceramic, 330pF, 10%, 1000V	C50B569-1
C307	Ceramic, 5000pF, 20%, 500V	C50B567-2	R312	8.2K	R12DC822J	C318	Electrolytic, 10uF, 35V	C50483-2
C308	Ceramic, .02uF, +80-20%, 100V	C50B570-2	R313	6.8K	R12DC682J	C319	Ceramic, .02uF, +80-20%, 500V	C50095-1
C309	Electrolytic, 4uF, 35V	C50483-1	R314	3.3K	R12DC332J	C320	Ceramic, .01uF, +80-20%, 500V	C50B570-1
C310	Ceramic, 100pF, 10%, N1500, 1000V		R315	1.5K	R12DC152J			
C311	Ceramic, .01uF, +80-20%, 500V	C50B568-3	R316	220	R12DC221J			
C312	Ceramic, 5000pF, 20%, 500V	C50B567-2	R317	1K	R12DC102J			
C313	Ceramic, 3pF, 10%, NPO, 1000V	C50070-28	R318	12K	R12DC123J			
C314	Ceramic, 5000pF, 20%, 500V	C50B567-2	R319	6.8K	R12DC682J			
C315	Ceramic, .01uF +80-20%, 500V	C50B570-1	R320	4.7K	R12DC472J			
C316, 317	Ceramic, 330pF, 10%, 1000V	C50B569-1	R321	1.5K	R12DC152J			
C318	Electrolytic, 10uF, 35V	C50483-2	R322	100	R12DC101J			
C319	Ceramic, .02uF, +80-20%, 500V	C50095-1	R323, 324	1K	R12DC102J			
C320	Ceramic, .01uF, +80-20%, 500V	C50B570-1	R325, 326	6.8K	R12DC682J			
			R327	22K	R12DC223J			

### RESISTORS

Deposited carbon in ohms, 5% tolerance, 1/8 watt, unless otherwise noted. K=Kilohms, M=Megohms.

Symbol	Description	Part No.
R301	6.8K	R12DC682J
R302	3.3K	R12DC332J
R303	22	R12DC220
R304	3.3K	R12DC332J
R305	12K	R12DC123J

### MISCELLANEOUS

Symbol	Description	Part No.
CR301, 302	Diode, AA112	TR2N2654
Z301, 302	Transformer, I. F.	A506 8
Z303	Coil, Limiter	P138
Z304	Transformer, Ratio Detector	
Q301, 302, 303, 304	Transistor 2N2654	
	Transistor Mtg. Pads	
	Printed Circuit Board	

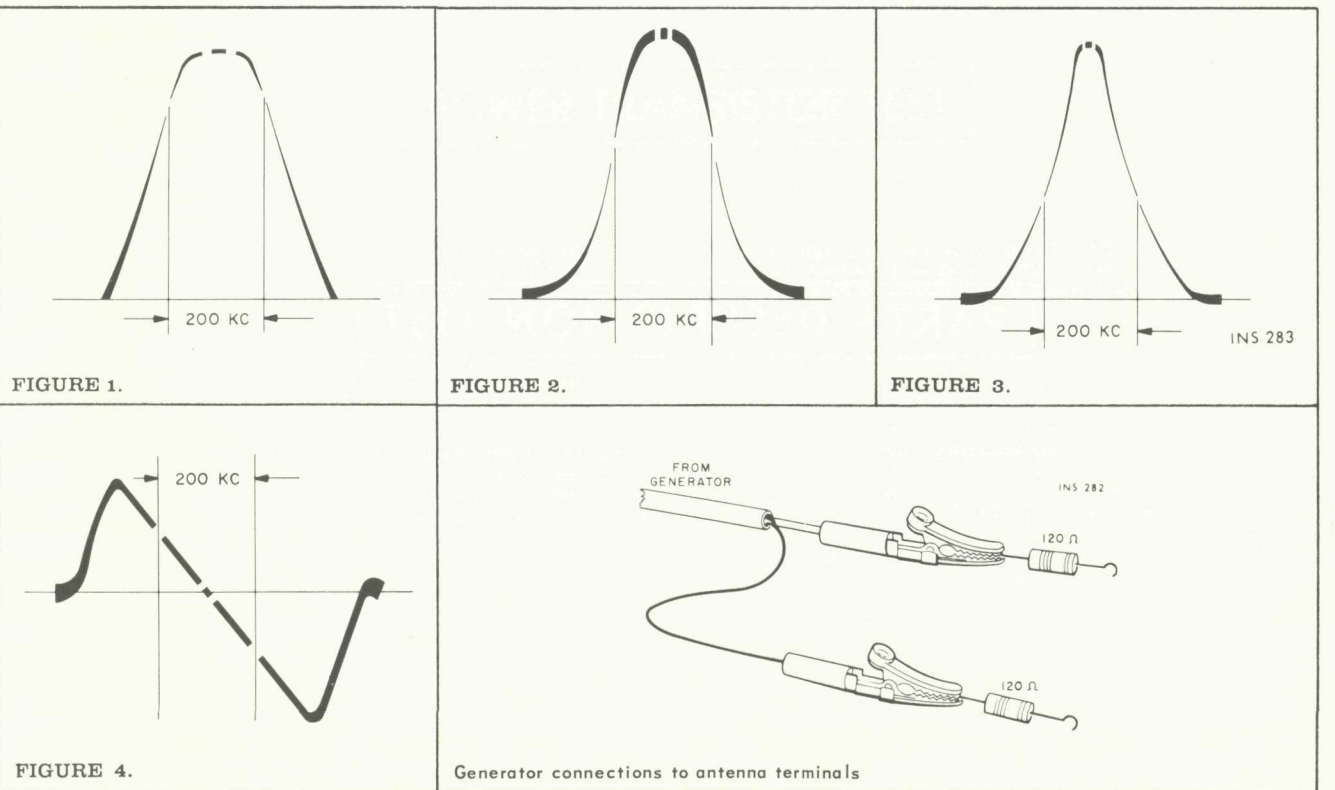
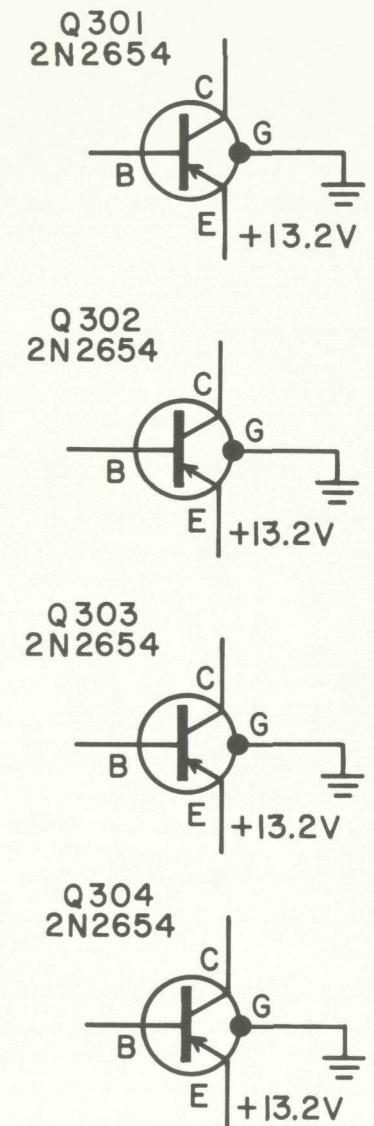
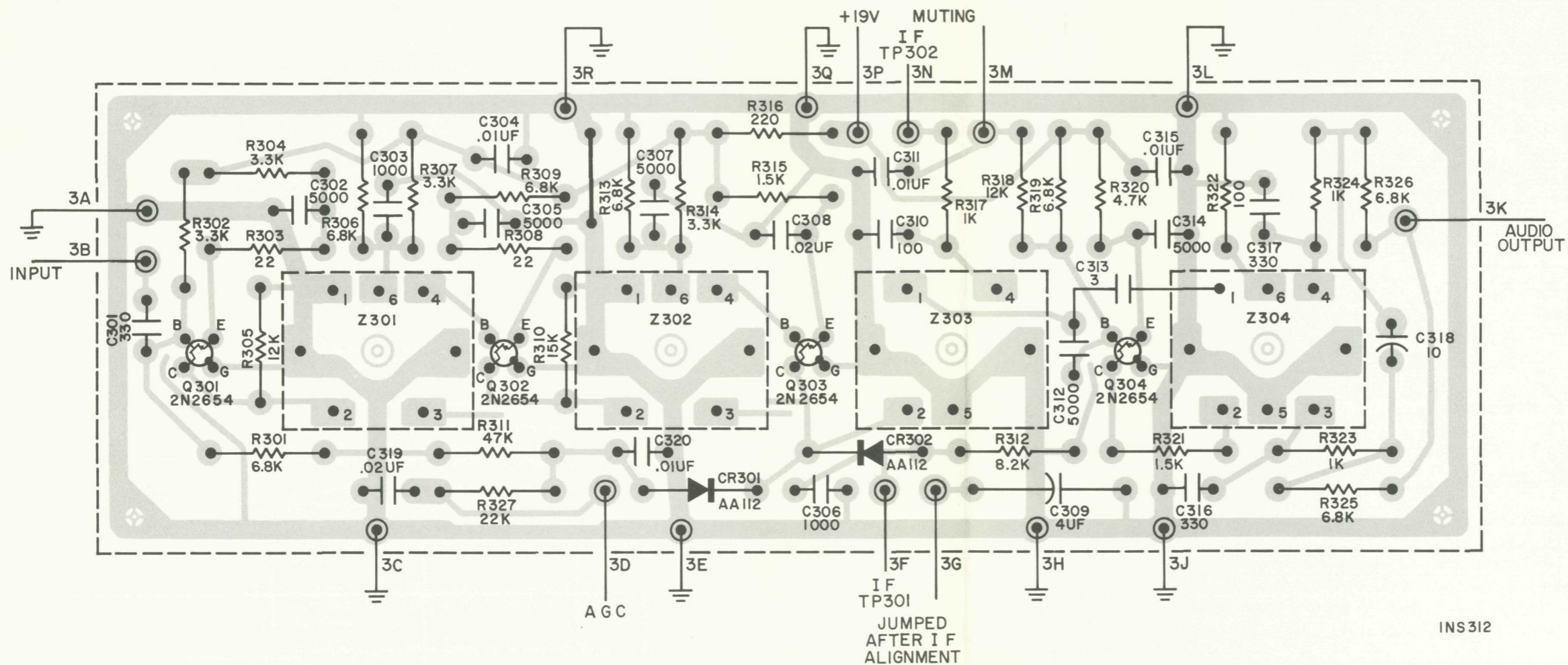

FIGURE 4.

Generator connections to antenna terminals



## 1381 IF AMPLIFIER



### IF ALIGNMENT

- Connect 10.7-mc generator output lead to the collector of Q302. DO NOT use modulation (AM or FM).
- Connect DC VTVM across C318 (ratio-detector filter). Use 100K resistor in series with each lead—DO NOT ground VTVM.
- Adjust Z303 (bottom core) and Z304 (top and bottom cores) for maximum DC VTVM reading. Readjust generator output, during alignment, to keep DC VTVM reading between 4 and 5.5 volts.
- Connect DC VTVM and scope leads (through 100 K resistors) to TP301. Disconnect jumper between 3F and 3G on printed-circuit board.
- Connect sweep generator to point 3B of IF amplifier board. Adjust top and bottom cores of Z301 and Z302, and bottom core of Z303 for maximum gain and a symmetrical response curve (Figure 1) on scope. Adjust

- generator output during alignment to keep DC VTVM reading between -0.5 and -2.0 volts.
- Connect sweep generator output lead to TP751 (front end). Adjust top and bottom cores of Z751 for maximum gain and a symmetrical response curve on the scope. Generator output must be adjusted during alignment to keep DC VTVM reading between -0.5 and -1.5 volts. The IF response curve should now be like that in Figure 2.
- Connect scope vertical input to point 3N on the printed-circuit board and adjust the top core of Z303 for maximum gain and a response curve like that in Figure 3.
- Reconnect jumper between 3F and 3G.
- Connect scope vertical input to the left or right REC OUT jack. Ratio-detector response curve should be like that in Figure 4.

### FM TUNING METER CALIBRATION

- Connect FM generator output leads to the LOCAL antenna terminals through two 120-ohm composition resistors—one connected in series with each lead.
- Set FM generator frequency and FM TUNING dial pointer to 90 MHz (MC).
- Set FM generator output to 100 mV,  $\pm 22.5$  kHz (KC) deviation at 400 Hz (CPS).
- Rotate the FM METER ADJUST potentiometer (R37) shaft for a meter reading of 4.

### FM MUTING ADJUSTMENT

- Connect FM generator output leads to the LOCAL antenna terminals through two 120-ohm composition resistors—one connected in series with each lead.

- Set FM generator frequency and FM TUNING dial pointer to 90 MHz (MC).
- Set FM generator output to 16  $\mu$ V,  $\pm 25$  kHz (KC) deviation at 400 Hz (CPS).
- Connect AC (audio) VTVM to the left (or right) RCRDR OUT jack.
- Set MUTING to OFF position and make note of the AC VTVM reading.
- Turn MUTING to ON position and rotate the FM MUTING ADJUST potentiometer (R26) shaft for an AC VTVM reading 1 to 5 db lower than that previously noted.
- Reduce FM generator output to zero—no signal (400 Hz modulation) or noise should be present at the RCRDR OUT jacks.
- Increase FM generator output to 30  $\mu$ V. Reading on AC VTVM should now be approximately the same as the reading obtained with MUTING in the OFF position.

INS312

# 1242 MULTIPLEX DECODER

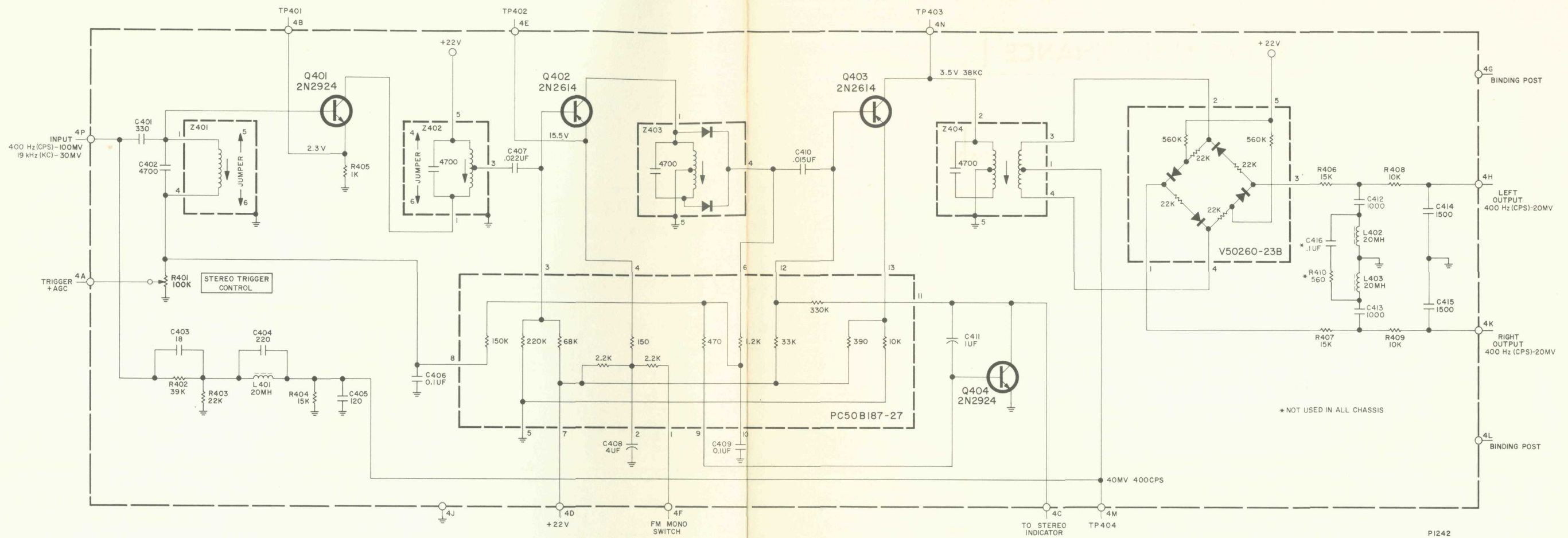

## PARTS DESCRIPTION LIST

CAPACITORS		
Symbol	Description	Part No.
C401	Ceramic, 330pF, 10%, 1000V	C50B569-1
C402	Mica, Silver, 4700pF, 5%, 100V	C50B571-2
C403	Ceramic, 18pF, 5%, 1000V, P100	C50B568-15
C404	Polystyrene, 220pF, 5%, 33V	C50B636-3
C405	Polystyrene, 120pF, 5%, 33V	C50B636-8
C406	Mylar, .1uF, 10%, 250V	C50B638-7
C407	Mylar, .022uF, 10%, 250V	C50B638-3
C408	Electrolytic, 4uF, 35V	C50B637-1
C409	Mylar, .1uF, 10%, 250V	C50B638-7
C410	Mylar, .015uF, 10%, 250V	C50B638-2
C411	Electrolytic, 1uF, 70V	C50B637-2
C412, 413	Polystyrene, 1000pF, 5%, 33V	C50B636-9
C414, 415	Polystyrene, 1500pF, 5%, 33V	C50B636-24
*C416	Mylar, .1uF, 20%, 250V	C50B575

RESISTORS AND POTENTIOMETERS		
In ohms, 5% tolerance, 1/8 watt unless otherwise noted. K = Kilohms, M = Megohms.		
Symbol	Description	Part No.
R401	Potentiometer, Trigger Control 100K, 30%	R50150-65

R402	Dep. Carbon, 39K
R403	Dep. Carbon, 22K
R404	Dep. Carbon, 15K
R405	Composition, 1K, 10%, 1/2W
R406, 407	Dep. Carbon, 15K
R408, 409	Dep. Carbon, 10K
*R410	Dep. Carbon, 560

MISCELLANEOUS	
Symbol	Description
-	Printed Circuit Board
-	Printed Circuit
-	Socket, Transistor
-	Ring Demodulator
L401, 402, 403	Choke, Coil, 20mh
Q401, 404	Transistor, 2N2924
Q402, 403	Transistor, 2N2614
Z401	Transformer, 19kc
Z402	Transformer, 19kc
Z403	Transformer, 19kc
Z404	Transformer, 38kc

R12DC393J
R12DC223J
R12DC153J
RC20BF102K
R12DC153J
R12DC103J
R12DC561J

Part No.	
P1242	Printed Circuit
PC50B187-27	Printed Circuit
X50B779-2	Socket, Transistor
V50260-23B	Ring Demodulator
L50334-6	Choke, Coil, 20mh
TR2N2924-18	Transistor, 2N2924
TR2N2614	Transistor, 2N2614
ZZ50B210-80	Transformer, 19kc
ZZ50B210-76	Transformer, 19kc
ZZ50B210-74	Transformer, 19kc
ZZ50B210-75	Transformer, 19kc

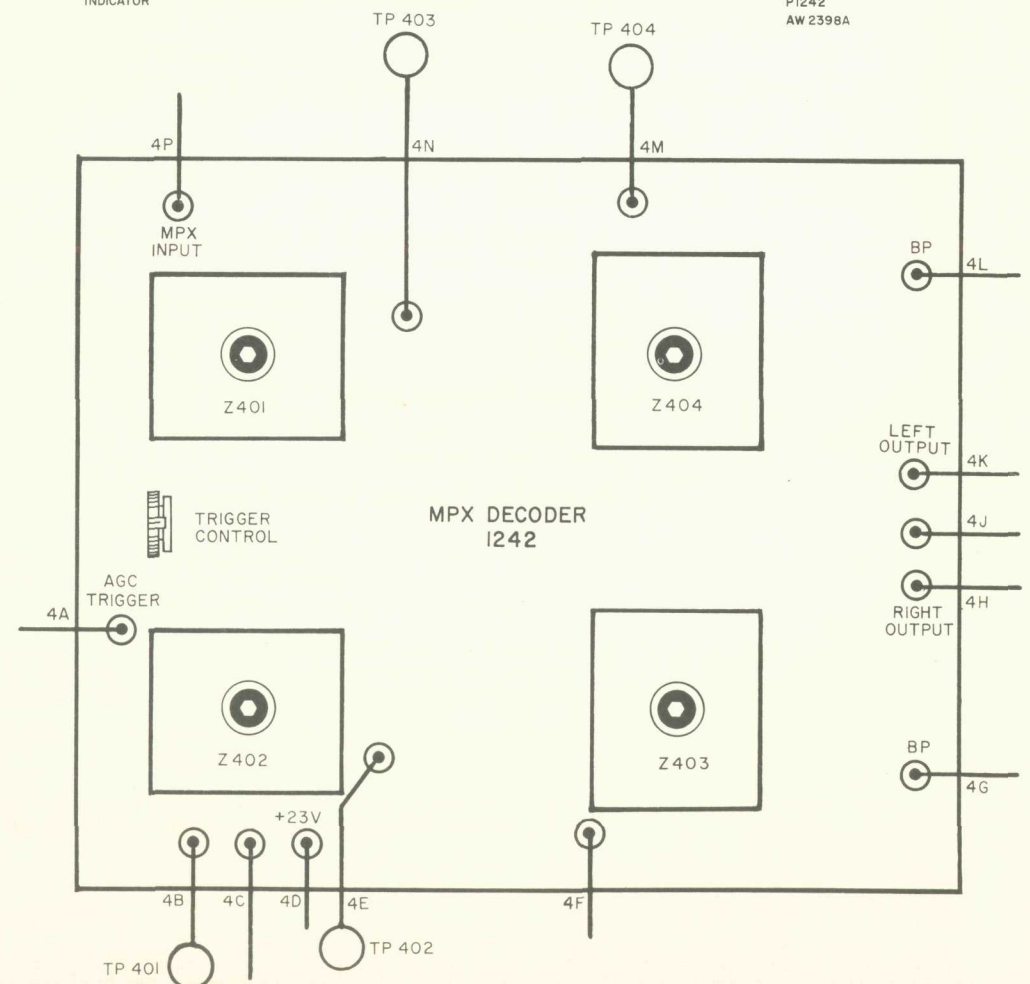

\* Not used in all chassis

# 1242 MULTIPLEX DECODER

## MULTIPLEX DECODER TESTS

- Modulate FM generator with 19 kc,  $\pm 6.5$  kc deviation. (Use external modulation if necessary.)
- Connect the FM generator output to the antenna terminals of the unit under test.
- With the FM generator set for an output of 25  $\mu$ V at the antenna terminals the stereo indicator should light up. If the generator output is reduced to 5  $\mu$ V, at the antenna terminals, the indicator light should remain ON.
- Reduce FM generator output to zero and the indicator light should go OFF.
- If the stereo indicator light does not respond properly to the tests above, readjust the trigger control (R401) until the stereo indicator lamp just turns ON with a 4  $\mu$ V signal applied to the antenna terminals.

## PREFERRED ALIGNMENT INSTRUCTIONS

(Using multiplex generator with RF and 19 kc outputs and with 1 kc modulation)

In Table 1, below, a multiplex generator with an RF output is used. This is the better method of alignment since the multiplex circuitry is connected to the tuner with which it will be used. Check the alignment of the IF stages before making multiplex adjustments. Poor IF alignment can make proper multiplex operation impossible.

**TEST EQUIPMENT:** Multiplex Generator, Audio (AC) Vacuum-Tube Voltmeter (RMS type preferred), Vacuum-Tube Voltmeter (DC VTVM), Oscilloscope (100 kc minimum) with external sweep input.

**WARNING:** Use only the proper alignment tool to prevent core breakage.

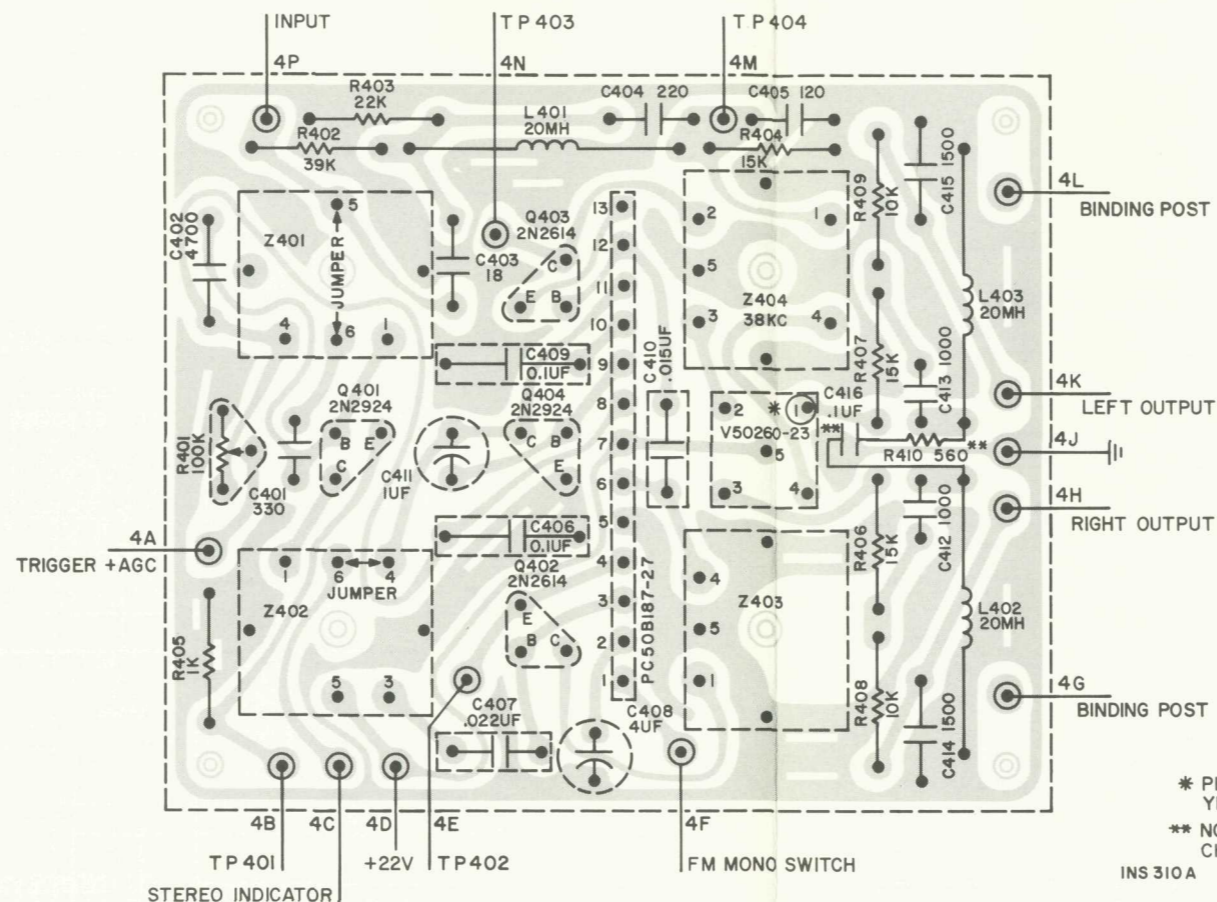

\* PIN NO.1 MARKED BY YELLOW DOT.  
\*\* NOT USED IN ALL CHASSIS  
INS 310A

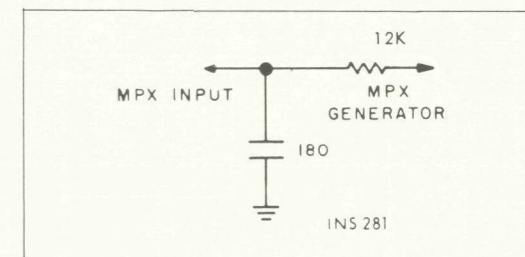

FIGURE 1. Multiplex-alignment pass filter circuit.

## ALTERNATE ALIGNMENT INSTRUCTIONS

(For multiplex generators without an RF output)

Disconnect the ratio detector from the multiplex unit before using this procedure. A low-pass filter (Figure 1) is used between the MPX generator output and the input to the multiplex circuitry. It has about the same loading effect as the output of the ratio detector in the tuner.

TABLE 1

MULTIPLEX-GENERATOR RF OUTPUT CONNECTED TO ANTENNA TERMINALS

STEP	GENERATOR MODULATION	RF DEV.	INDICATOR TYPE AND CONNECTION	ALIGNMENT	
				ADJUST	INDICATION
1	70 to 76 kc (connect external audio generator to SCA input of multiplex generator.)	$\pm 25$ kc	Audio (AC) VTVM input to TP404 with 10-pF capacitor in series with test lead.	--	Read minimum AC voltage between 70 and 76 kc..
2	19 kc pilot only	$\pm 6.5$	AC VTVM to TP403	Z401, 402, 403 and 404	Maximum AC voltage (38 kc)
3	Composite MPX signal 1 kc on left channel only	$\pm 75$ kc	Audio (AC) VTVM and oscilloscope vertical input to left channel output lug (4H)	Z402	Maximum AC voltage with clean 1 kc sine wave on oscilloscope
4	Composite MPX signal 1 kc on right channel only	$\pm 75$ kc	Same as Step 3	MPX Separation Control (located on chassis).	Minimum reading on Audio (AC) VTVM--should be at least 35db below reading obtained in Step 3.
5	Same as Step 4	$\pm 75$ kc	Audio (AC) VTVM and oscilloscope vertical input to right channel output lug (4K)	--	Same Audio (AC) VTVM reading as obtained in Step 3 ( $\pm 2$ db); clean 1kc sine wave on scope.
6	Same as Step 4	$\pm 75$ kc	Same as Step 5		Minimum reading on Audio (AC) VTVM should be at least 35db below reading in Step 5.

TABLE 2

COMPOSITE OUTPUT OF MULTIPLEX GENERATOR CONNECTED TO INPUT OF MPX DECODER THROUGH LOW-PASS FILTER

STEP	GENERATOR MODULATION	LEVEL (RMS)	INDICATOR TYPE AND CONNECTION	ALIGNMENT	
				ADJUST	INDICATION
1	70 to 76 kc.	100mV	Audio (AC) VTVM input to TP404 with 10-pF capacitor in series with test lead.	--	Read minimum AC voltage between 70 and 76 kc.
2	19 kc pilot only	50mV	AC VTVM to TP403	Z401, 402, 403 and 404	Maximum AC voltage (38 kc)
3	Composite MPX signal 1 kc on left channel only	300mV	Audio (AC) VTVM and oscilloscope vertical input to left channel output lug (4H)	Z402	Maximum AC voltage with clean 1 kc sine wave on oscilloscope
4	Composite MPX signal 1 kc on right channel only	300mV	Same as Step 3	MPX Separation Control (located on chassis).	Minimum reading on Audio (AC) VTVM--should be at least 35db below reading obtained in Step 3.
5	Same as Step 4	300mV	Audio (AC) VTVM and oscilloscope vertical input to right channel output lug	--	Same Audio (AC) VTVM reading as obtained in Step 3 ( $\pm 2$ db); clean 1kc sine wave on scope.
6	Same as Step 4	300mV	Same as Step 5		Minimum reading on Audio (AC) VTVM should be at least 35db below reading obtained in Step 5.

# HOME MAINTENANCE

## 1. Cleaning The Dial Glass

Before cleaning the dial glass, disconnect the power plug from the wall socket, as a precaution. Next, proceed as follows:

- (1) Remove all control knobs from their shafts by gently pulling them away from the dress panel. Do not remove the pushbuttons.
- (2) Remove the nuts that are fastened to the shafts of the Volume and Muting controls.
- (3) Lift off the dress panel, to expose the chassis.
- (4) Loosen the screws that fasten down the dial glass retaining clips. (When you replace the dial glass, make certain to reset it by placing it firmly against the lower left-hand corner.) Swing the clips aside, and then lift off the glass.
- (5) Remove dust with a dry cloth. If you wish to clean more thoroughly, use a *soap and water solution only*; if you use any stronger cleaning agent, you may damage the markings on the glass.
- (6) Replace the dial glass, dress panel and knobs by reversing the procedure outlined in steps (1) through (4), above.

## 2. Replacing Dial Lamps

In order to replace the dial lamps, it is necessary to remove the knobs and dress panel. Disconnect the power plug from the wall socket as a precaution, before proceeding.

- (1) Remove the dress panel, as outlined in Paragraph 1, steps (1) through (3).
- (2) The lamps, tubular in shape, are held in place at either end of the dial glass by spring clips, and can be removed by lifting gently.
- (3) Install a new lamp, making sure that the white-painted side faces away from the dial glass. Press the lamp down until it snaps into place.
- (4) Replace the dress panel by reversing steps (1) through (3) of Paragraph 1.

Replacement lamps are available from the Parts Department of Fisher Radio Corporation, Long Island City 1, N. Y., as Part No. I50441-5.

## 3. Stereo Beacon Lamp

This lamp is a long-life device which should not require replacement with normal use.

## 4. Replacing Tuning Meter Lamp

- (1) Disconnect the power plug from the AC wall socket as a precaution and then locate the tuning-meter lamp. It is directly behind the tuning meter (on the underside of the receiver's front panel) and can be reached from the rear of the console.
- (2) Remove the metal shade from the burned-out lamp and keep it for use with the replacement lamp (No. 18470F, available at your authorized FISHER dealer or at any electronics parts dealer).
- (3) Remove the burned-out lamp by pushing it into its socket and twisting it *counterclockwise* until it disengages.
- (4) Install the new lamp by pushing it into the socket and twisting it *clockwise* until it engages. Slip the shade over the lamp.

# TUNER • SCHEMATIC

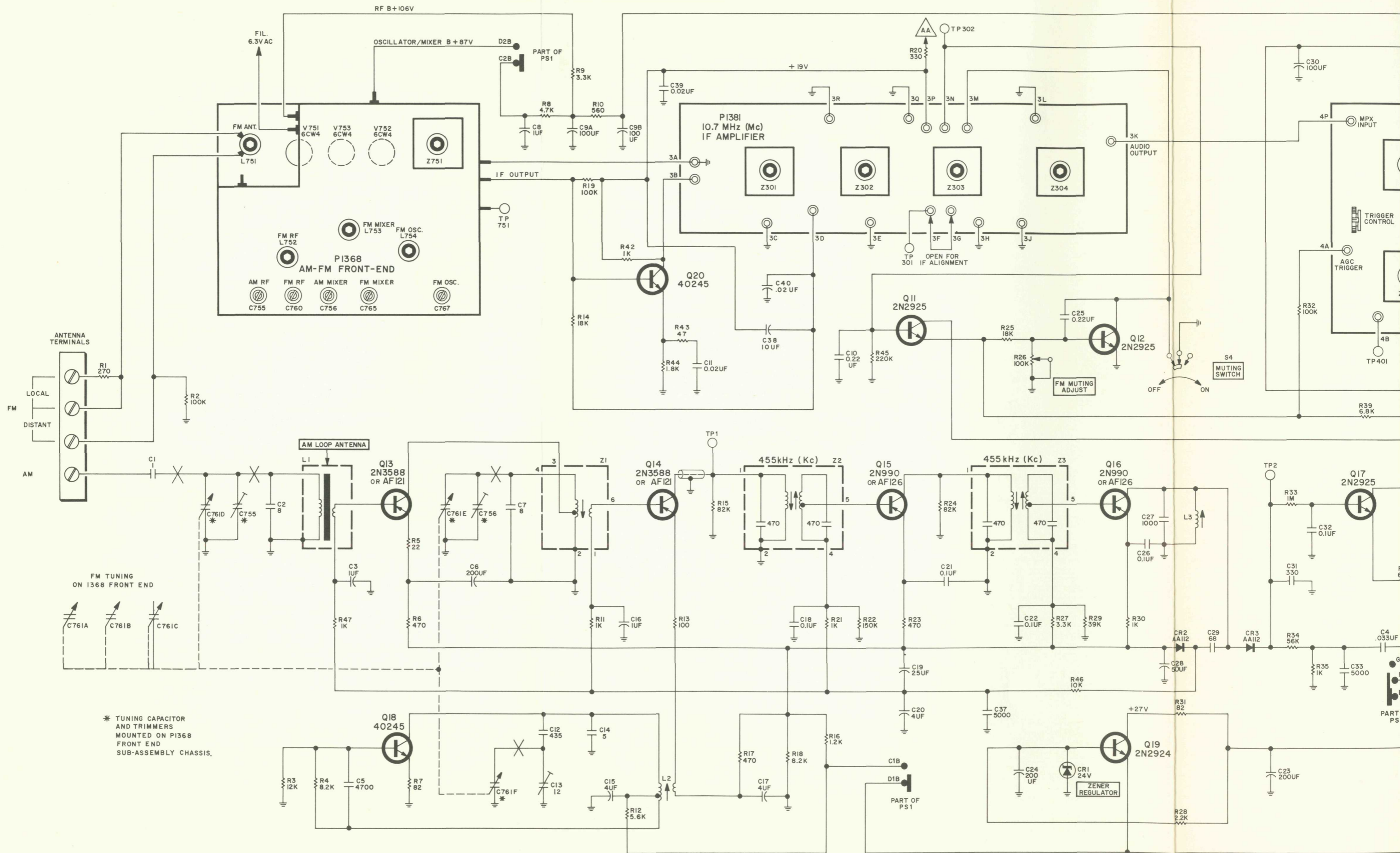

\* TUNING CAPACITOR AND TRIMMERS MOUNTED ON PI368 FRONT END SUB-ASSEMBLY CHASSIS.

# TUNER • SCHEMATIC

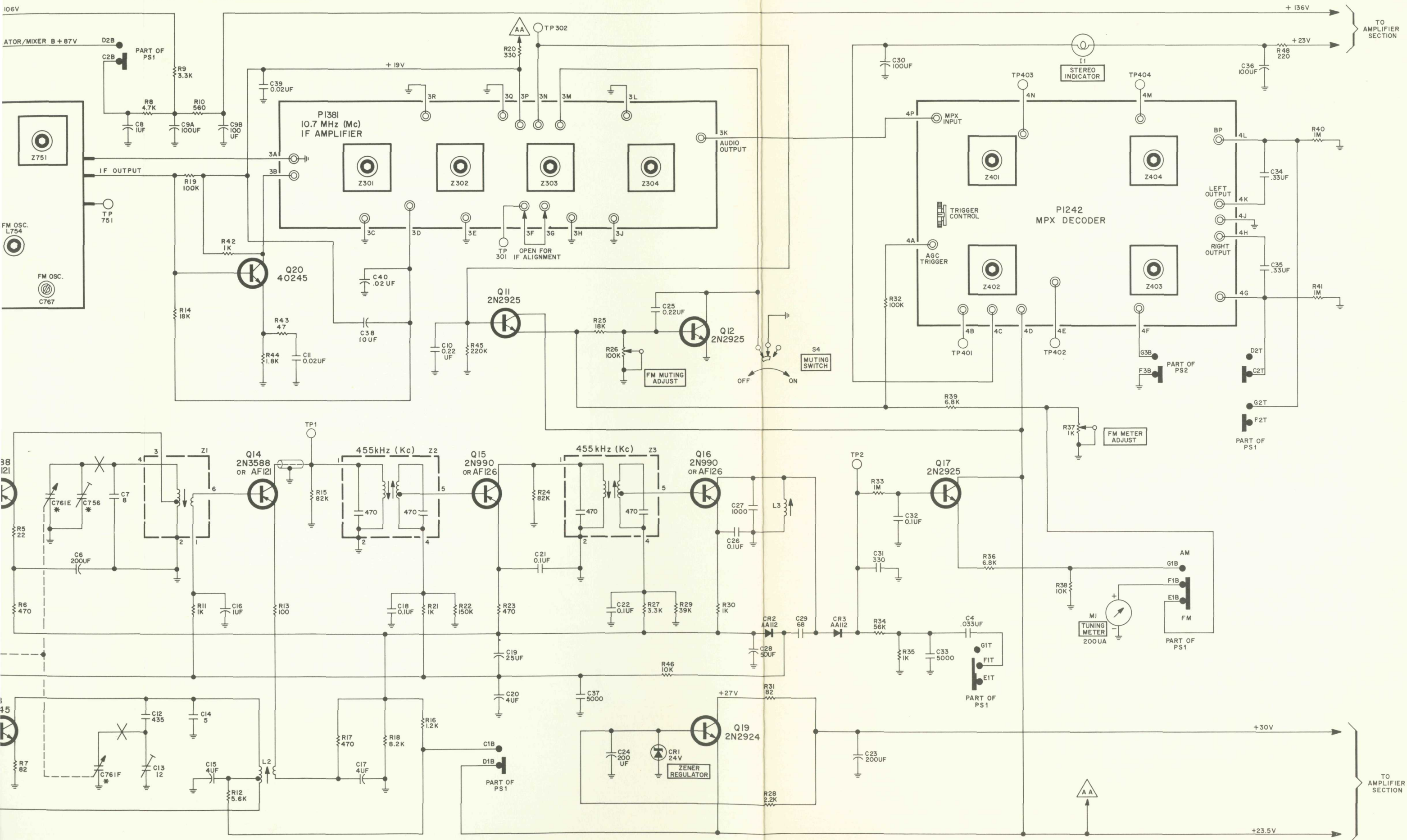

# AMPLIFIER • SCHEMATIC

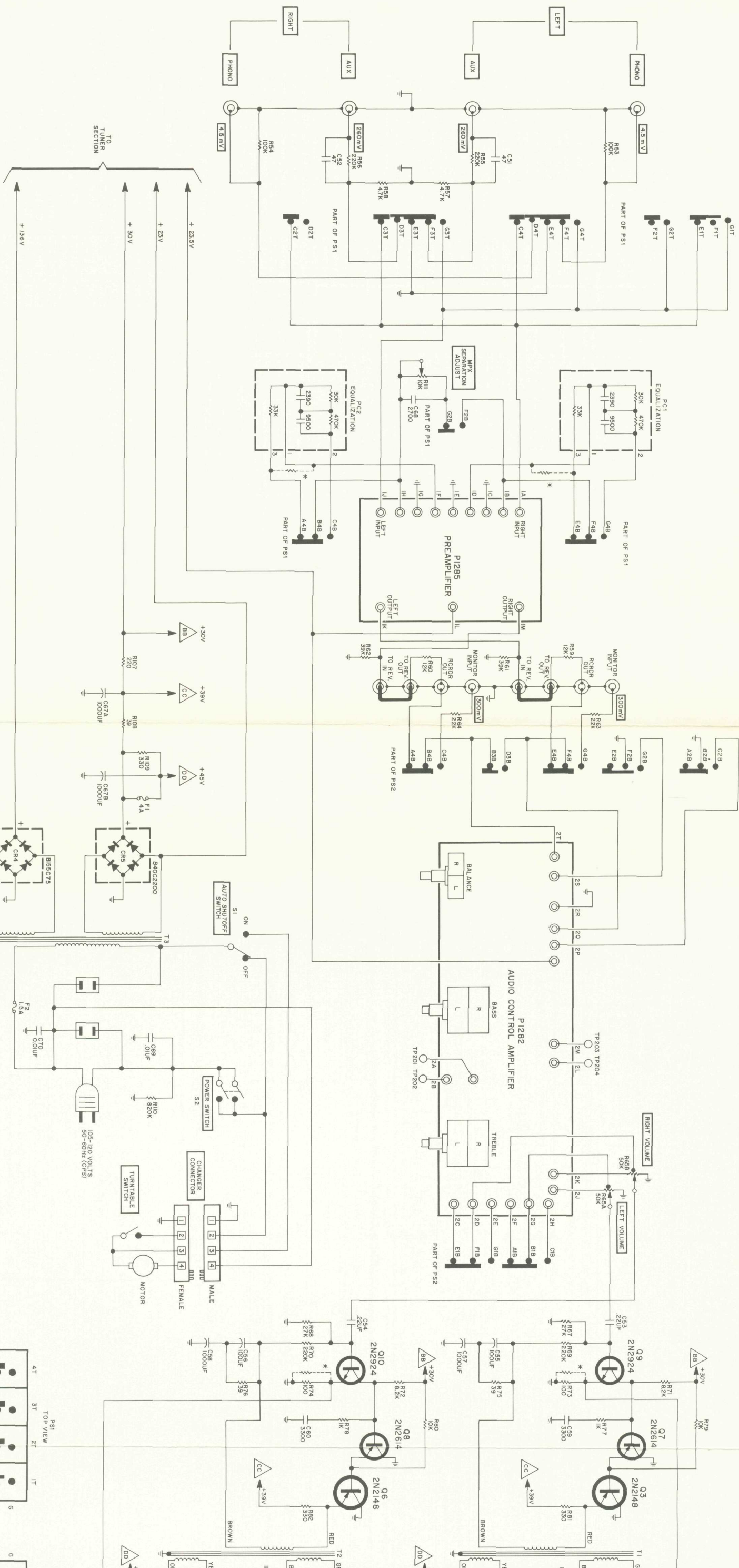

- NOTES:**
1. FOR ALL VOLTAGE AND CURRENT MEASUREMENTS LINE VOLTAGE = 117 VAC TO CHASSIS WITH NO SIGNAL INPUT.
  2. DC VOLTAGE MEASURED WITH DC#VTVM.
  3. USE AC#VTVM FOR IHKING SIGNAL TRACING.
  4. [ ] INDICATES SIGNALS FROM INPUTS INDICATED TO PA OUTPUT - LINE VOLTAGE 4.0 LOAD.
  5. FOR ALL SWITCH CONTACTS THAT ARE NOT CONNECTED, SEE SCHEMATIC DIAGRAM OF TUNER SECTION.

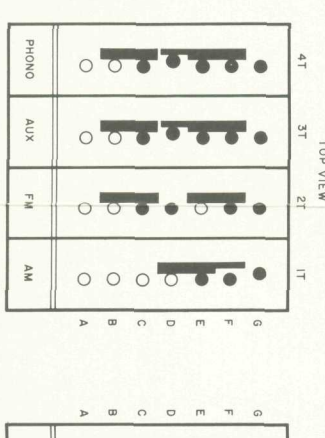
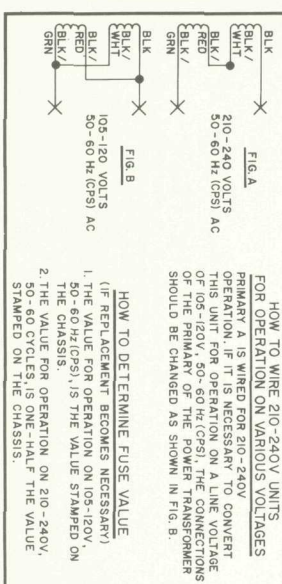
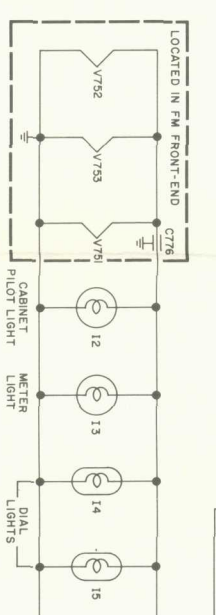

BECAUSE ITS PRODUCTS ARE SUBJECT TO CONTINUOUS IMPROVEMENT, FISHER RADIO CORPORATION RESERVES THE RIGHT TO MODIFY ANY DESIGN OR SPECIFICATION WITHOUT NOTICE AND WITHOUT INCURRING ANY OBLIGATION.

# AMPLIFIER • SCHEMATIC

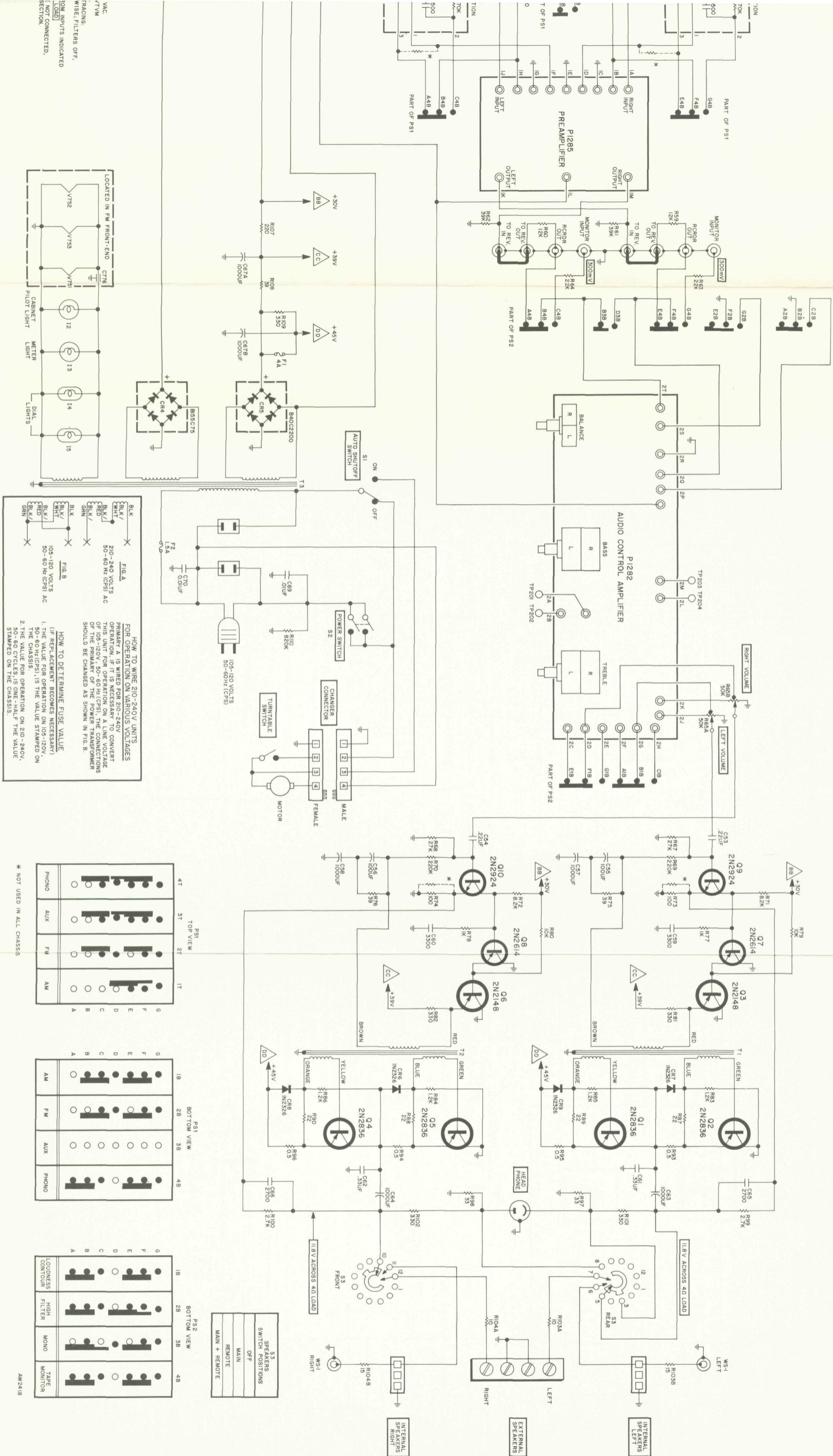

**HOW TO WIRE 210-240V UNITS FOR OPERATION ON VARIOUS VOLTAGES**  
 PRIMARY A IS WIRED FOR 210-240V OPERATION. IF IT IS NECESSARY TO CONVERT THIS UNIT FOR OPERATION ON A LINE VOLTAGE OF 105-120V, 50-60 HZ (CPS), THE CONNECTIONS OF THE SECONDARY WINDING OF THE TRANSFORMER SHOULD BE CHANGED AS SHOWN IN FIG. B.

**HOW TO DETERMINE FUSE VALUE (IF REPLACEMENT BECOMES NECESSARY)**  
 1. THE VALUE FOR OPERATION ON 105-120V, 50-60 HZ (CPS), IS THE VALUE STAMPED ON THE CHASSIS.  
 2. THE VALUE FOR OPERATION ON 210-240V, 50-60 CYCLES, IS ONE-HALF THE VALUE STAMPED ON THE CHASSIS.

**FIG. A**  
 210-240 VOLTS  
 50-60 HZ (CPS) AC

**FIG. B**  
 105-120 VOLTS  
 50-60 HZ (CPS) AC



# TROUBLESHOOTING GUIDE

Does not go on (pilot or dial lamps do not light).

- Set AUTO SHUTOFF to OFF.

Check:

- Fuse F2.
- AC plug and line cord.
- Wall outlet.
- Power switch S2 (use test lamp in *switched* AC outlet on rear of chassis).

Fuse F1 blows as soon as replaced.

Check:

- C67B
- Internal speaker systems, jacks, plugs and interconnecting cables for shorts.
- External speakers and connections and WS1 jacks.  
(Quick check can be made by using SPEAKERS switch to disconnect speakers.)

Test:

- Q1, Q2, Q4, Q5.

Fuse F2 blows as soon as replaced.

Check:

- CR4, C9, R10.
- C776 (Filament bypass in front end).
- CR5, C67, R108.
- C36, R48.

Distortion – (one or both channels) – in any INPUT SELECTOR position.

Hum or  
No audio output

- Set TAPE MONITOR to OFF (out) position.
- Set BALANCE, BASS and TREBLE controls to NORMAL.
- Remove cable plugs in RCRDR OUT, REV IN and REV OUT jacks (insert jumpers between REV IN and REV OUT jacks).

Check:

- CR5, C67, C23, Q19, C24, CR1.
- Audio Control Amplifier circuitry.
- Preamplifier circuitry and PS1.

Distortion, (either or both channels) INPUT SELECTOR set for AM.

Hum, Weak or  
No audio output

- Try other broadcast stations.
- Reverse AC line-cord plug in wall outlet.

Check:

- PS1, R16, R12 for 23.5 volts.
- AM RF/IF alignment.

Test:

- Q13, Q14, Q15, Q16, Q18, Q19, CR2, CR3. and associated circuit components.

TUNING METER (AM) has little or no pointer movement.

- Tune to other AM broadcast stations.

Check:

- Antenna, lead-in and connection terminal.

Test:

- Q17, C32, R33, R36, R38.

Distortion, (either or both channels) INPUT SELECTOR set for FM.

Hum, Weak or  
No audio output

- Set MUTING (S4) to OFF position.
- Tune to other FM broadcast stations.
- Reverse AC line-cord plug in wall outlet.

Check:

- FM RF/IF alignment.
- Antenna, lead-in and connection terminals.
- FM IF amplifier circuitry.
- MPX DECODER circuitry.

Test:

- V751, V752, V753 or substitute.
- Q11, Q12, Q20.

TUNING METER (FM) has little or no pointer movement.

Check:

- Setting of R26 (FM MUTING ADJUST).
- Setting of R37 (FM METER ADJUST).
- Continuity through PS1.

Test:

- Q11, Q12.

STEREO BEACON does not indicate (FM STEREO works).

- Set MODE SELECTOR to STEREO.
- Set INPUT SELECTOR to FM.
- Tune to strong-signal station (watch tuning meter).

Check:

- I1 indicator lamp.
- MPX Decoder TRIGGER CONTROL setting.
- MPX Decoder circuitry.

FM STEREO does not work (FM MONO normal).

- Set MODE SELECTOR to STEREO.
- Set INPUT SELECTOR to FM.
- Tune to strong-signal station (watch tuning meter).

Check:

- MPX SEPARATION ADJUST (R111).
- Operation of MODE SELECTOR.
- Continuity (look for shorts) through MODE SELECTOR.
- MPX Decoder circuitry.

# 1282 CONTROL AMPLIFIER

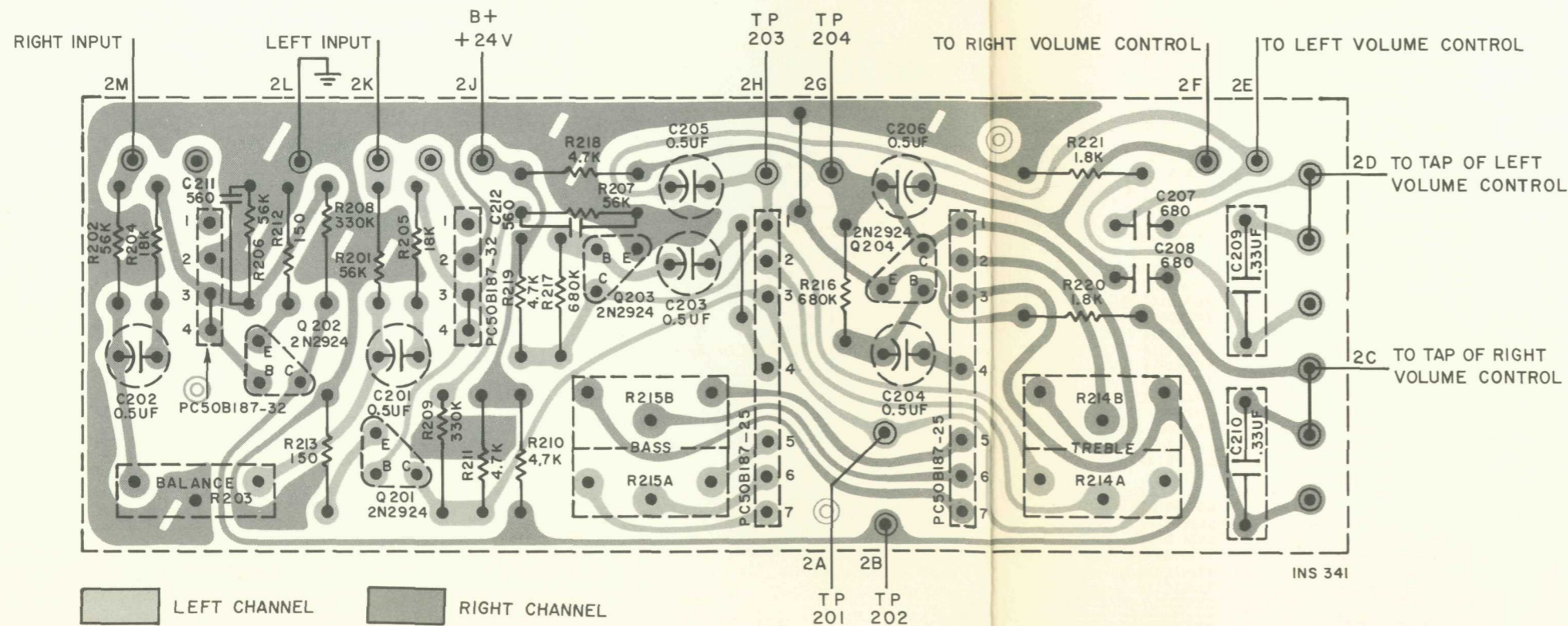
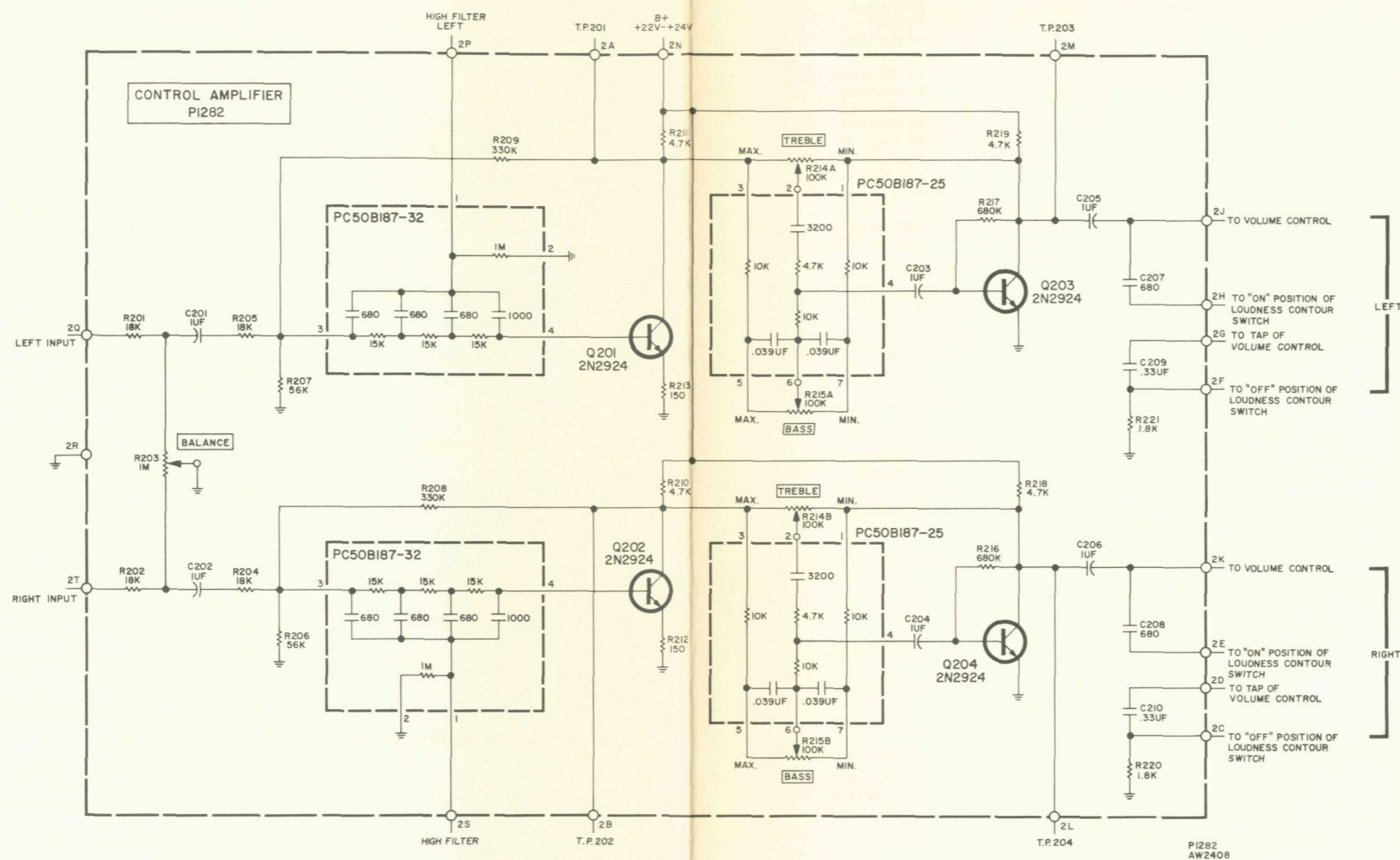

CAPACITORS		
Symbol	Description	Part No.
C201, 202, 203, 204, 205, 206	Electrolytic, 1uF, 70V	C50B637-2
C207, 208	Ceramic, 680pF, 10%, 1000V	C50B569-2
C209, 210	Mylar, .33uF, 10%, 250V	C50B638-10

RESISTORS		
Symbol	Description	Part No.
R201, 202	Dep. Carbon, 18K, 5%, 1/8W	R12DC183J
R203	Pot., 500K, Balance Control	R50160-185
R204, 205	Dep. Carbon, 18K, 5%, 1/8W	R12DC183J
R206, 207	Dep. Carbon, 56K, 5%, 1/8W	R12DC563J
R208, 209	Dep. Carbon, 330K, 5%, 1/8W	R12DC334J
R210, 211	Composition, 4.7K, 10%, 1/2W	RC20BF472K
R212, 213	Dep. Carbon, 150, 5%, 1/8W	R12DC151J
R214A, B	Pot., Dual, 100K, Treble	R50160-184
R215A, B	Pot. Dual, 100K, Bass	R50160-184
R216, 217	Dep. Carbon, 680K, 5%, 1/8W	R12DC684J
R218, 219	Composition, 4.7K, 10%, 1/2W	RC20BF472K

MISCELLANEOUS		
Symbol	Description	Part No.
---	Printed Circuit, Hi-Filter	PC50B187-32
---	Printed Circuit, Tone Control	PC50B187-25
Q201, 202, 203, 204	Transistor, 2N2924	TR2N2924-18

# MAIN CHASSIS PARTS DESCRIPTION LIST

## CAPACITORS

Symbol	Description	Part No.
C1	Ceramic, 1pF, ±.25pF, P100, 1000V	C50070-1
C2	Ceramic, 8pF, 10%, NPO, 1000V	C50070-14
C3	Electrolytic, 1uF, 70V	C50483-16
C4	Mylar, .033uF, 10%, 100V	C50B574-11
C5	Polystyrene, 4700pF, 5%, 50V	C50B573-23
C6	Electrolytic, 200uF, 35V	C50483-7
C7	Ceramic, 8pF, 10%, NPO, 1000V	C50070-14
C8	Electrolytic, 1uF, 350V	C50283-3
C9 A, B	Electrolytic, 100/100uF, 150V	C50180-85
C10	Mylar, .22uF, 10%, 250V	C50B575-2
C11	Ceramic, .02uF, +80 -20%, 100V	C50095-1
C12	Polystyrene, 435pF, 1%, 125V	CP50394-24
C13	Trimmer, Ceramic, 12pF	C50B792-1
C14	Ceramic, Tubular, 5pF, ±.5pF, N5600, 500V	CC20H3M050D5
C15	Electrolytic, 4uF, 35V	C50483-1
C16	Electrolytic, 1uF, 70V	C50483-16
C17	Electrolytic, 4uF, 35V	C50483-1
C18	Mylar, .1uF, 20%, 250V	C50B575-1
C19	Electrolytic, 25uF, 35V	C50483-12
C20	Electrolytic, 4uF, 35V	C50483-1
C21, 22	Mylar, .1uF, 20%, 250V	C50B575-1
C23, 24	Electrolytic, 200uF, 35V	C50483-7
C25	Mylar, .22uF, 10%, 250V	C50B575-2
C26	Mylar, .1uF, 20%, 250V	C50B575-1
C27	Polystyrene, 1000pF, 5%, 33V	C50B636-9
C28	Electrolytic, 50uF, 35V	C50483-4
C29	Ceramic, 68pF, 10%, N750, 1000V	C50070-16
C30	Electrolytic, 100uF, 25V	C50483-6
C31	Polystyrene, 330pF, 5%, 50V	C50B573-4
C32	Mylar, .1uF, 20%, 250V	C50B575-1
C33	Ceramic, 5000pF, 20%, 500V	C50089-1
C34, 35	Mylar, .33uF, 10%, 250V	C50B575-4
C36	Electrolytic, 100uF, 25V	C50483-6
C37	Ceramic, 5000pF, 20%, 500V	C50089-1
C38	Electrolytic, 10uF, 35V	C50483-2
C39, 40	Ceramic, .02uF, +80 -20%, 100V	C50095-1
C41 thru 50	-Unused designations-	- - -
C51, 52	Ceramic, 47pF, 10%, N750, 1000V	C50070-4
C53, 54	Mylar, .22uF, 10%, 250V	C50B575-2
C55, 56	Electrolytic, 100uF, 15V	C50483-5
C57, 58	Electrolytic, 1000uF, 15V	C50283-10
C59, 60	Ceramic, 3300pF, 10%, 1000V	C50072-11
C61, 62	Mylar, .33uF, 20%, 250V	C50B575-6
C63, 64	Electrolytic, 1000uF, 50V	C50180-80
C65, 66	Ceramic, 2700pF, 10%, 1000V	C50072-17
C67A, B	Electrolytic, 1000/1000uF, 50V	C50180-83
C68	Ceramic, 2700pF, 20%, 1000V	C50071-5
C69, 70	Molded, .01uF, 20%, 600V	C2747

## RESISTORS AND POTENTIOMETERS

Deposited Carbon, in ohms, 5% tolerance, 1/8 Watt unless otherwise noted. K=Kilohms, M=Megohms.

Symbol	Description	Part No.
R1	Composition, 270, 10%, 1/2W	RC20BF271K
R2	Composition, 100K, 10%, 1/2W	RC20BF104K
R3	12K	R12DC123J
R4	8.2K	R12DC822J
R5	22	R12DC220J
R6	470	R12DC471J
R7	82	R12DC820J
R8	Composition, 4.7K, 10%, 1/2W	RC20BF472K
R9	Composition, 3.3K, 10%, 1/2W	RC20BF332K
R10	Wirewound, 560, 5%, 2W	RW200W561J
R11	1K	R12DC102J
R12	5.6K	R12DC562J
R13	100	R12DC101J
R14	18K	R12DC183J
R15	82K	R12DC823J
R16	1.2K	R12DC122J
R17	470	R12DC471J
R18	8.2K	R12DC822J
R19	100K	R12DC104J
R20	330	R12DC331J
R21	1K	R12DC102J
R22	150K	R12DC154J
R23	470	R12DC471J
R24	82K	R12DC823J
R25	18K	R12DC183J
R26	Pot., 5K, FM Muting Adj.	R50150-11
R27	3.3K	R12DC332J
R28	Composition, 2.2K, 10%, 1/2W	RC20BF222K
R29	39K	R12DC393J
R30	1K	R12DC102J
R31	Composition, 82, 10%, 1/2W	RC20BF820K
R32	100K	R12DC104J

R33	1M	R12DC105J
R34	56K	R12DC563J
R35	1K	R12DC102J
R36	6.8K	R12DC682J
R37	Pot., 1K, FM Meter Adj.	R50150-51
R38	10K	R12DC103J
R39	6.8K	R12DC682J
R40, 41	1M	R12DC105J
R42	1K	R12DC102J
R43	47	R12DC470J
R44	1.8K	R12DC182J
R45	220K	R12DC224J
R46	10K	R12DC103J
R47	1K	R12DC102J
R48	Wirewound, 220, 5%, 2W	RW200W221J
R49	Composition, 3.3K, 10%, 1/2W	RC20BF332K
R50 thru 52	-Unused designations-	- - -
R53, 54	100K	R12DC104J
R55, 56	220K	R12DC224J
R57, 58	4.7K	R12DC472J
R59, 60	12K	R12DC123J
R61, 62	39K	R12DC393J
R63, 64	22K	R12DC223J
R65A, B	Pot. 50K, Dual, Volume	R50160-186
R66	-Deleted-	- - -
R67, 68	27K	R12DC273J
R69, 70	220K	R12DC224J
R71, 72	8.2K	R12DC822J
R73, 74	100	R12DC101J
R75, 76	39	R12DC390J
R77, 78	1K	R12DC102J
R79, 80	10K	R12DC103J
R81, 82	Glass, 330, 10%, 3W	RP3W331K
R83, 84,		
85, 86	1.2K, 1/2W	R50DC122J
R87, 88,		
89, 90	22	R12DC220J
R91, 92	-Deleted-	- - -
R93, 94,		
95, 96	Wirewound, 0.5, 5%, 3W	RL300WR50J
R97, 98	Composition, 33, 10%, 1/2W	RC20BF330K
R99, 100	2.7K	R12DC272K
R101, 102	Wirewound, 330, 5%, 2W	RW200W331J
R103A, B,		
104A, B	Wirewound, Dual 15/10, 10%, 10W	R50500-2BX
R105, 106	-Deleted-	- - -
R107	Wirewound, 220, 5%, 2W	RW200W221J
R108	Wirewound, 39, 5%, 2W	RW200W390J
R109	Wirewound, 330, 5%, 3W	RL300W331J
R110	Composition, 820K, 10%, 1/2W	RC20BF824K
R111	Pot. 1K, MPX Sep. Control	R50150-51

## MISCELLANEOUS

Symbol	Description	Part No.
CR1	Diode, Zener Regulator	ZR50B793-3
CR2, 3	Diode, Germanium AA112	V50260-16
CR4	Rectifier, Selenium Bridge	SEB50B795-1
CR5	Rectifier, Silicon Bridge	S1B50B794-1
CR6, 7,		
8, 9	Diode, 2N2326	GET50825-1
F1	Fuse, 4 Amp	F3319-4
F2	Fuse, 1.5 Amp, Slo-Blo	F684-143
I1	Lamp, Stereo Beacon	I50594
I2	Lamp, Cabinet	I50009-7
I3	Lamp, Meter	I50009-8
I4, 5	Lamp, Dial	I50441-5
L1	Coil, AM Ferrite-Antenna	L50B210-85
L2	Coil, AM Oscillator	L50B210-84
L3	Coil, AM IF	L50B210-86
M1	Meter, Tuning	M946B213
PC1, 2	Printed-Circuit, Equalization	PC50B187-30
Q1, 2, 4, 5	Transistor, 2N2836	TR2N2836
Q3, 6	Transistor, 2N2148	TR2N2148
Q7, 8	Transistor, 2N2614	TR2N2614
Q9, 10, 19	Transistor, 2N2924	TR2N2924
Q11, 12, 17	Transistor, 2N2925	TR2N2925
Q13, 14	Transistor, 2N3588 (or AF121)	TR2N3588
Q15, 16	Transistor, 2N990 (or AF126)	TR2N990
Q18, 20	Transistor, 40245	TR40245
PS1	Switch, P. B. Input Selector	S1281B130
PS2	Switch, P. B. Mode Selector	S1281B131
S1	Switch, Automatic Shutoff	S50358-9
S2	Switch, Power (On Volume Control, R65)	R50160-186
S3	Switch, Speaker Selector	S1281B133
S4	Switch, Muting	S1281B132
T1	Transformer, Driver	T1281C139-1
T2	Transformer, Driver	T1281C139-2
T3	Transformer, Power	T1281C115
Z1	Coil, AM RF	ZZ50B210-87
Z2, 3	Transformer, AM IF	ZZ50B210-83
- - -	Dial Glass, Screened	N1281B107

# CHASSIS LAYOUT

TOP VIEW

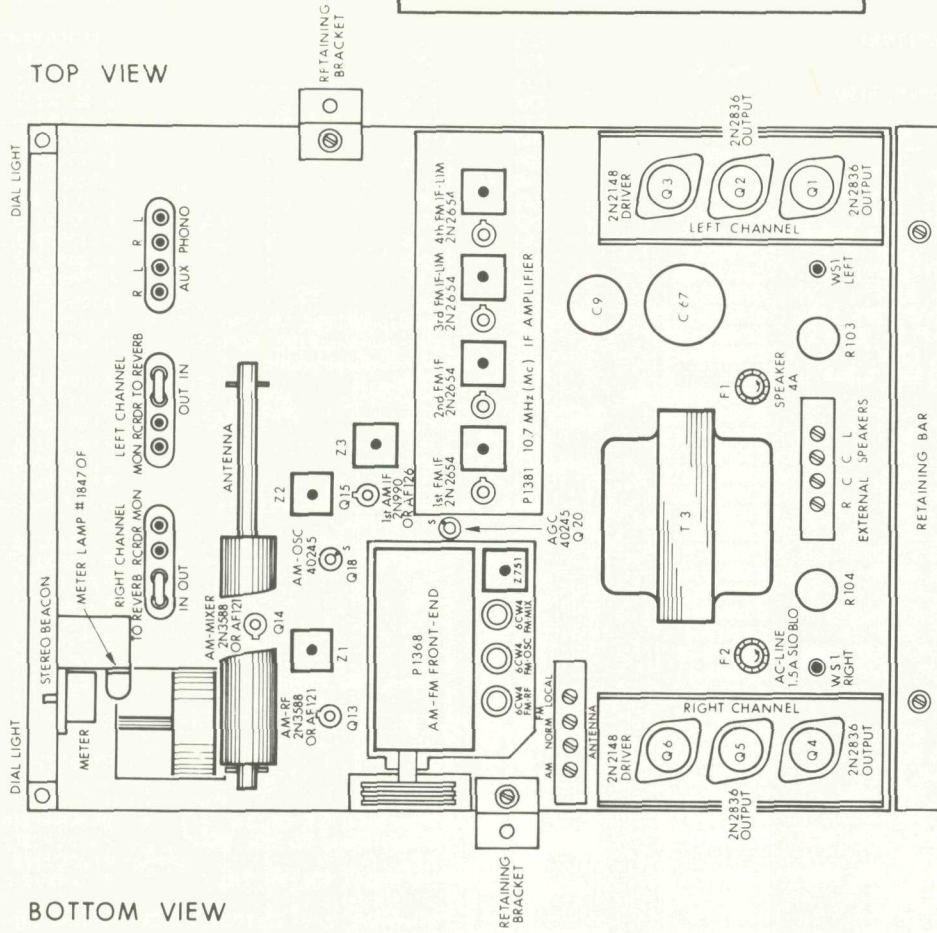

BOTTOM VIEW

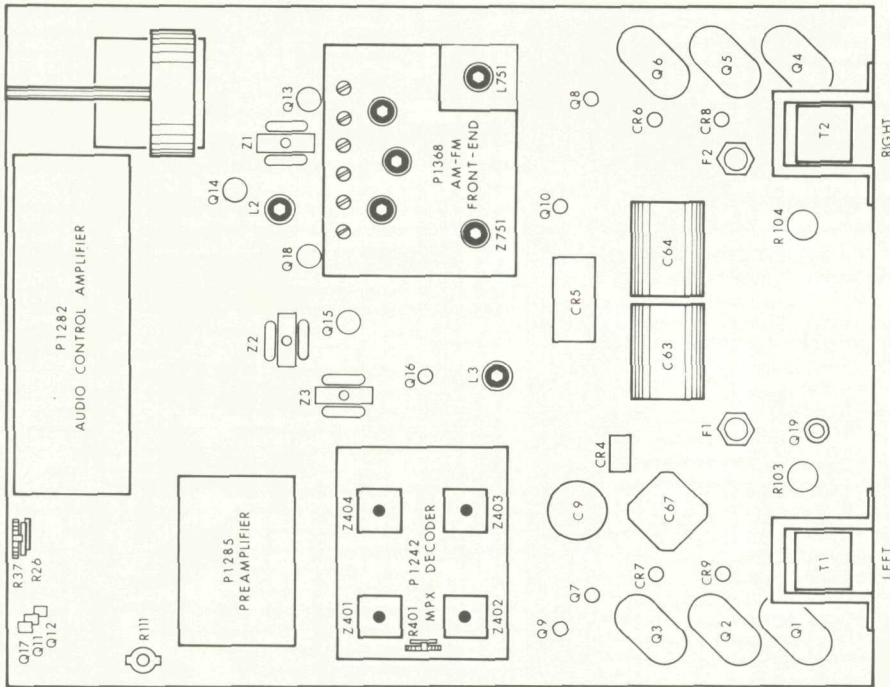

FISHER RADIO CORPORATION • NEW YORK

